

Figure 1. Physical Photos of AHVR12V600V16MAP

FEATURES

- Output Voltage Proportional to Input Voltage
- Output Voltage from 0 to 600V
- Input Voltage from 0.7V to 12V
- Low Power Consumption
- High Efficiency
- High Stability
- Low Turn-on Voltage 0.7VDC
- Input to Output Isolation
- Small Output Ripple, Time Drift, and Temperature Drift
- Overload and Short Circuit Protection
- Metal Enclosure for Zero EMIS
- Easy Control and Installation

APPLICATIONS

This power module, AHVR12V600V16MAP, is designed for achieving DC-DC conversion from low voltage to high voltage as a power supply source. It can be used for:

- X-ray Machine
- Spectral Analysis
- Nondestructive Inspection
- Semiconductor Manufacturing Equipment
- Capillary Electrophoresis
- Physical Vapor Phase Deposition
- Electrospinning Preparation of Nanofiber
- DC Reactive Magnetron Sputtering

Table 1. Pin Names, Functions and Specifications

No.	Name	Description	Type	Min.	Typ.	Max.
1	+V _{IN}	Input Voltage	Power supply input	0V		12V
2	-V _{IN}	Input Ground	Ground for power supply		0V	
3	-V _{OUT}	Output Ground	Power output		0V	
4	+V _{OUT}	Output Voltage	Power output	0V		600V
5	NC	No Connect	-		-	



DESCRIPTION

AHVR12V600V16MAP comes with a quasi-sine wave oscillator, a fully enclosed transformer, an input and output filter, and a five-sided metal enclosure. These modules present low EMI/RFI, low noise, and low ripple. The input and output are galvanically isolated. Proportional to the input voltage, the output voltage has a typical turn-on voltage as low as 0.7V. It also comes with output short-circuit protection and a wide range of output voltage adjustments. This high voltage power supply also features ultra-small size, light weight, moisture proof, shockproof, metal enclosure, and zero EMIs.

USING AHVR12V600V16MAP

This high voltage power supply must be mounted tightly onto a metal plate, ideally, thus expanding its heating sinking capacity of the metal enclosure. Sufficient ventilation must be provided to keep the power supply surface temperature under 55°C.

SAFETY PRECAUTIONS

Although AHVR12V600V16MAP high voltage power supply comes with an over current protection circuit, a short circuit at the output should always be avoided. Make sure the high voltage wire for connecting VOUT node has sufficient insulation capability with its surrounding objects.

BLOCK DIAGRAM

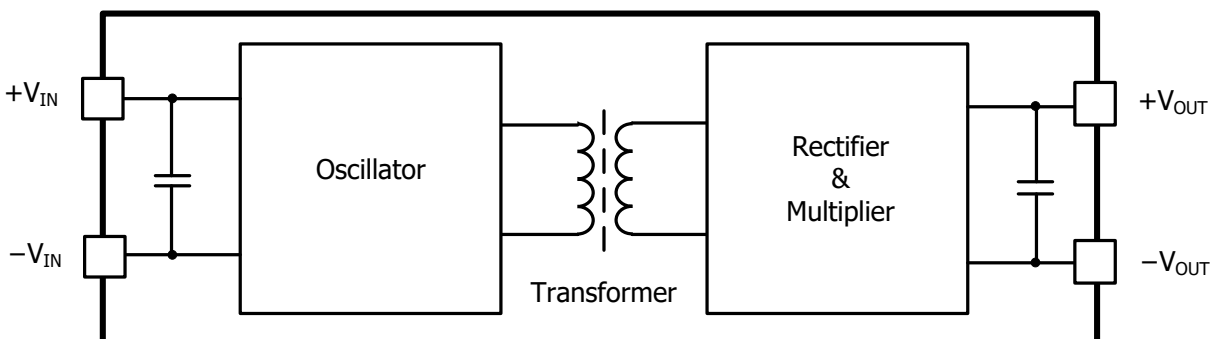

Figure 4. Block Diagram

APPLICATION NOTES

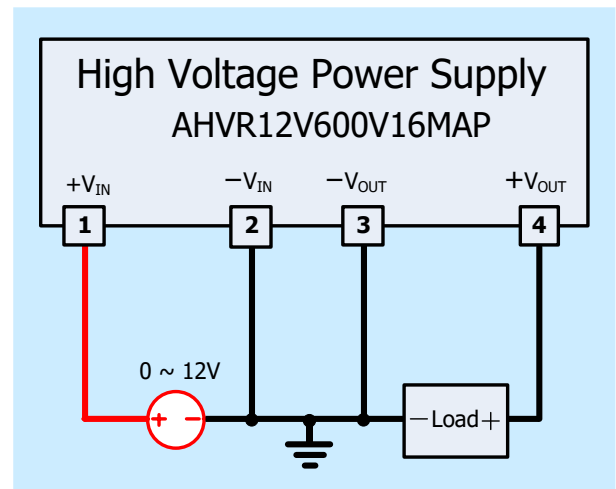

Figure 2. Positive Output

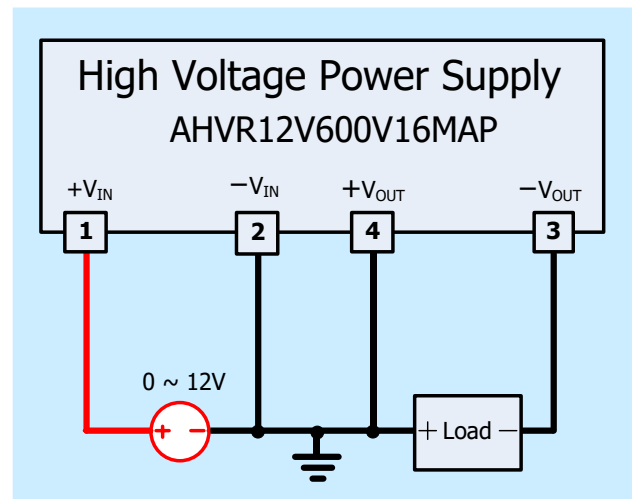

Figure 3. Negative Output



SPECIFICATIONS

Table 2. Characteristics. T_A = 25°C, unless otherwise noted.

Parameter	Symb ol	Test Conditions	Min.	Typ.	Max.	Unit/Note
Input Power Supply Voltage	V _{IN}		0.7		12	V
Input Power Supply Quiescent Current	I _{VPS_QC}	I _{VOUT} = 0mA	275	300	325	mA
Input Power Supply Current at Full Load	I _{VPS_FL}	I _{VOUT} = 16mA	1.1	1.2	1.3	A
Output Voltage Range	V _{VOUT}	I _{VOUT} = 0 ~ 16mA	0		600	V
Output Current Range	I _{VOUTMAX}	V _{IN} = 12V	0		16	mA
Output Load Resistance Range			$\frac{V_{VOUT}}{I_{VOUT}}$		∞	MΩ
Output Voltage Tolerance		At Max V _{OUT} , Full Load			±5	%
Output Voltage Ripple	V _{VOUT_RP}	R _{LOAD} = 37kΩ V _{VOUT} = 600V	≤1			V _{P-P}
Response Time	t _{RESPONSE}	0 to Max V _{OUT} , Full Load		260		ms
Isolation Voltage: Input to Output				3500		V
Switching Frequency	F _{SW}		25		125	kHz
Full Load Efficiency	η	V _{VPS} = 12V V _{VOUT} = 600V I _{VOUT} = 16mA		≥70		%
Output Voltage Temperature Stability		-20 ~ 50°C			±1	%
Operating Temperature Range	T _{opr}		-10		70	°C
Storage Temperature Range	T _{stg}		-25		90	°C
Humidity		Non-condensing		95		%RH
External Dimensions			71.1×43.2×21.6			mm
			2.80×1.70×0.85			inch
Weight				145		g
				0.32		lbs
				5.11		Oz



TESTING DATA

Test conditions: $V_{PS} = 12V$, $T_A = 25^\circ C$, $R_{LOAD} = 37k\Omega$

The measured output voltage, V_{OUT} , corresponding to the input voltage, V_{IN} , is shown in Figure 7.

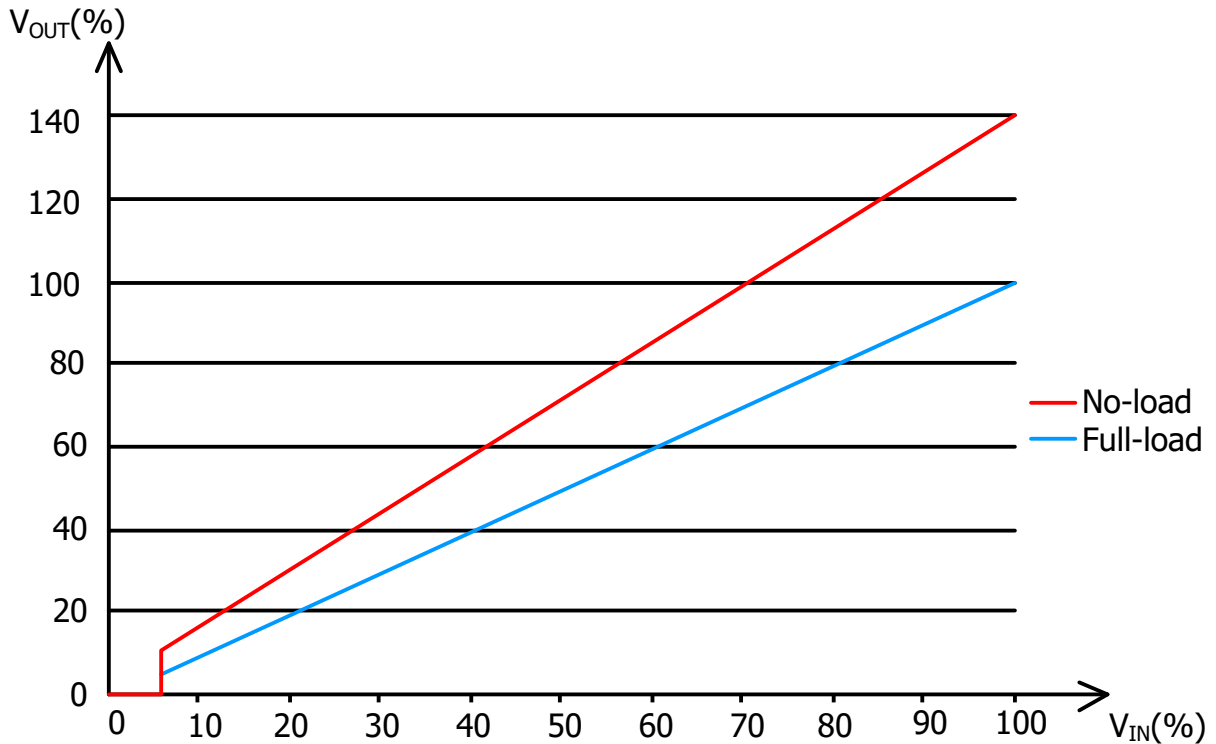

Figure 5. V_{IN} vs. V_{OUT}

NAMING PRINCIPLE

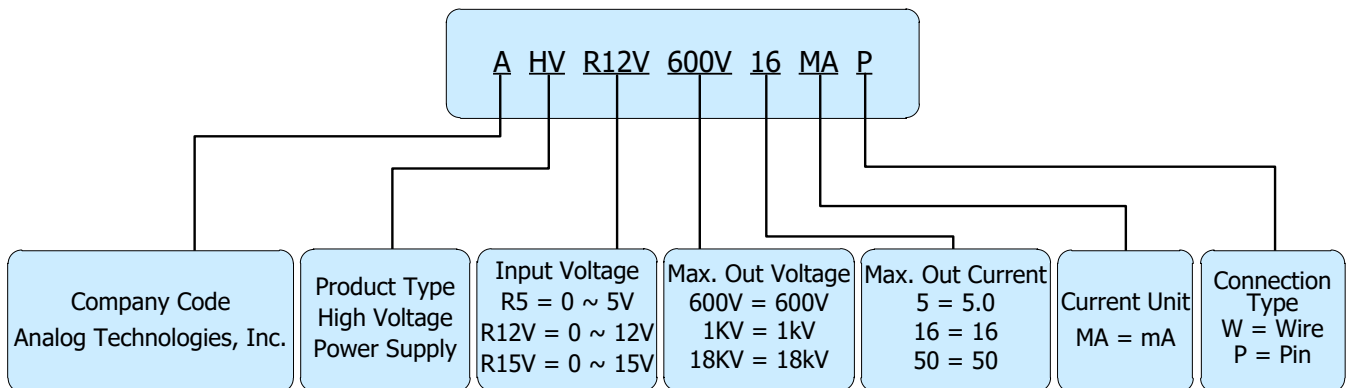

Figure 6. Naming Principle of AHVR12V600V16MAP



DIMENSIONS

Pin Layout

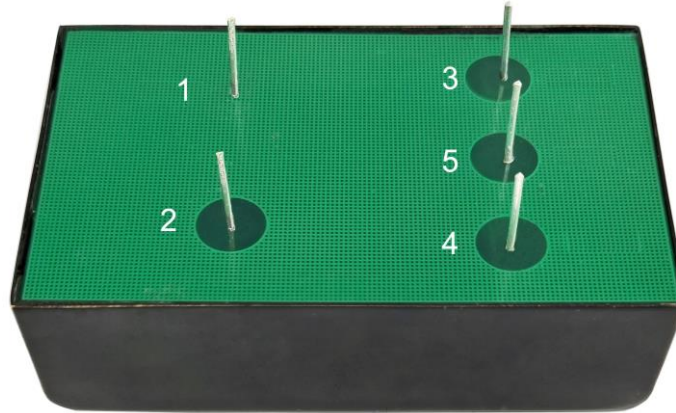

Figure 7. Pin Layout for AHVR12V600V16MAP

Outline Dimensions

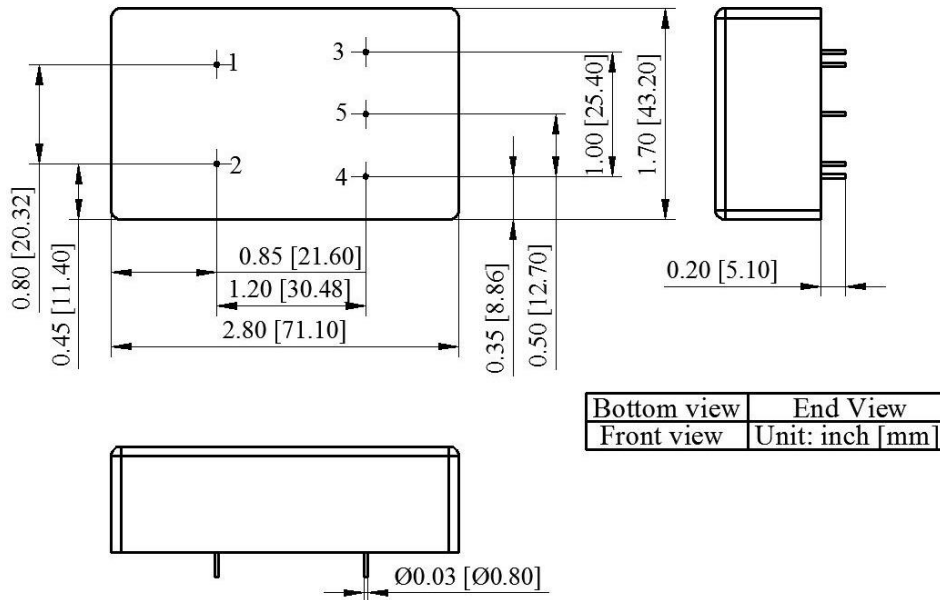

Figure 8. Outline Dimensions

ORDERING INFORMATION

Part Number	Buy Now
AHVR12V600V16MAP	* *

*: both and are our online store icons. Our products can be ordered from either one of them with the same pricing and delivery time.



RELATED PRODUCTS

Part #	Datasheet	Output Type	Output Voltage (V)	Output Current (mA)	Input Voltage (V)	Ripple (%)	Buy Now*
AHVR12V100V100MAP	Contact Us	Single Output	0 ~ 100 or 0 ~ -100	100	0 ~ 12	<0.6	Contact Us
AHVR12VPN100V50MAP2	Contact Us	Dual Output	0 ~ ±100	50	0 ~ 12	<1.0	Contact Us
AHVR12V200V50MAP	Contact Us	Single Output	0 ~ 200 or 0 ~ -200	50	0 ~ 12	<1.0	Contact Us
AHVR12V300V33R3MAP	Contact Us	Single Output	0 ~ 300 or 0 ~ -300	33.3	0 ~ 12	<1.0	Contact Us
AHVR12VPN150V33R3MAP2	Contact Us	Dual Output	0 ~ ±150	33.3	0 ~ 12	<1.0	Contact Us
AHVR12V400V25MAP	Contact Us	Single Output	0 ~ 400 or 0 ~ -400	25	0 ~ 12	<1.0	Contact Us
AHVR12VPN200V25MAP2	Contact Us	Dual Output	0 ~ ±200	25	0 ~ 12	<1.0	Contact Us
AHVR12V500V20MAP		Single Output	0 ~ 500 or 0 ~ -500	20	0 ~ 12	<1.0	* *
AHVR12V600V16MAP	Contact Us	Single Output	0 ~ 600 or 0 ~ -600	16	0 ~ 12	<1.0	Contact Us
AHVR12VPN300V25MAP2	Contact Us	Dual Output	0 ~ ±300	16	0 ~ 12	<1.0	Contact Us
AHVR12V800V12R5MAP	Contact Us	Single Output	0 ~ 800 or 0 ~ -800	12.5	0 ~ 12	<1.0	Contact Us
AHVR12V1KV10MAP		Single Output	0 ~ 1000 or 0 ~ -1000	12.5	0 ~ 12	<1.0	* *
AHVR12VPN500V10MAP2	Contact Us	Dual Output	0 ~ ±500	10	0 ~ 12	<1.0	Contact Us
AHVR12V1200V8R3MAP	Contact Us	Single Output	0 ~ 1200 or 0 ~ -1200	8.3	0 ~ 12	<1.0	Contact Us
AHVR12VPN600V8R3MAP2	Contact Us	Dual Output	0 ~ ±600	8.3	0 ~ 12	<1.0	Contact Us
AHVR12V1500V6R6MAP	Contact Us	Single Output	0 ~ 1500 or 0 ~ -1500	6.6	0 ~ 12	<1.0	Contact Us
AHVR12VPN750V6R6MAP2	Contact Us	Dual Output	0 ~ ±750	6.6	0 ~ 12	<1.0	Contact Us
AHVR12V2KV5MAP		Single Output	0 ~ 2000 or 0 ~ -2000	5	0 ~ 12	<1.0	* *
AHVR15V3KV3R3MAP		Single Output	0 ~ 3000 or 0 ~ -3000	3.3	0 ~ 15	<1.0	* *
AHVR15VPN1500V3R3MAP2	Contact Us	Dual Output	0 ~ ±1500	3.3	0 ~ 15	<1.0	Contact Us
AHVR15V4KV2R5MAP		Single Output	0 ~ 4000 or 0 ~ -4000	2.5	0 ~ 15	<1.0	* *
AHVR15VPN2KV2R5MAP2	Contact Us	Dual Output	0 ~ ±2000	2.5	0 ~ 15	<1.0	Contact Us
AHVR15V5KV2MAP		Single Output	0 ~ 5000 or 0 ~ -5000	2.0	0 ~ 15	<1.0	* *
AHVR15VPN2500V2MAP2	Contact Us	Dual Output	0 ~ ±2500	2.0	0 ~ 15	<1.0	Contact Us
AHVR15V6KV1R66MAP	Contact Us	Single Output	0 ~ 6000 or 0 ~ -6000	1.66	0 ~ 15	<1.0	Contact Us
AHVR15VPN3KV2MAP2	Contact Us	Dual Output	0 ~ ±3000	1.66	0 ~ 15	<1.0	Contact Us
AHVR15V8KV1R25MAP	Contact Us	Single Output	0 ~ 8000 or 0 ~ -8000	1.25	0 ~ 15	<2.5	Contact Us
AHVR15VPN4KV1R25MAP2	Contact Us	Dual Output	0 ~ ±4000	1.25	0 ~ 15	<2.5	Contact Us
AHVR15V10KV1MAP	Contact Us	Single Output	0 ~ 10000 or 0 ~ -10000	1.25	0 ~ 15	<2.5	Contact Us
AHVR15V12KVR83MAP	Contact Us	Single Output	0 ~ 12000 or 0 ~ -12000	0.83	0 ~ 15	<2.5	Contact Us
AHVR15VPN6KVR83MAP2	Contact Us	Dual Output	0 ~ ±6000	0.83	0 ~ 15	<2.5	Contact Us



NOTICE

1. It is important to carefully read and follow the warnings, cautions, and product-specific notes provided with electronic components. These instructions are designed to ensure the safe and proper use of the component and to prevent damage to the component or surrounding equipment. Failure to follow these instructions could result in malfunction or failure of the component, damage to surrounding equipment, or even injury or harm to individuals. Always take the necessary precautions and seek professional assistance if unsure about proper use or handling of electronic components.
2. Please note that the products and specifications described in this publication are subject to change without prior notice as we continuously improve our products. Therefore, we recommend checking the product descriptions and specifications before placing an order to ensure that they are still applicable. We also reserve the right to discontinue the production and delivery of certain products, which means that not all products named in this publication may always be available.
3. This means that while ATI may provide information about the typical requirements and applications of their products, they cannot guarantee that their products will be suitable for all customer applications. It is the responsibility of the customer to evaluate whether an ATI product with the specified properties is appropriate for their particular application.
4. ATI warrants its products to perform according to specifications for one year from the date of sale, except when damaged due to excessive abuse. If a product fails to meet specifications within one year of the sale, it can be exchanged free of charge.
5. ATI reserves the right to make changes or discontinue products or services without notice. Customers are advised to obtain the latest information before placing orders.
6. All products are sold subject to terms and conditions of sale, including those pertaining to warranty, patent infringement, and limitation of liability. Customers are responsible for their applications using ATI products, and ATI assumes no liability for applications assistance or customer product design.
7. ATI does not grant any license, either express or implied, under any patent right, copyright, mask work right, or other intellectual property right of ATI.
8. ATI's publication of information regarding third-party products or services does not constitute approval, warranty, or endorsement.
9. ATI retains ownership of all rights for special technologies, techniques, and designs for its products and projects, as well as any modifications, improvements, and inventions made by ATI.
10. Despite operating the electronic modules as specified, malfunctions or failures may occur before the end of their usual service life due to the current state of technology. Therefore, it is crucial for customer applications that require a high level of operational safety, especially in accident prevention or life-saving systems where the malfunction or failure of electronic modules could pose a risk to human life or health, to ensure that suitable measures are taken. The customer should design their application or implement protective circuitry or redundancy to prevent injury or damage to third parties in the event of an electronic module malfunction or failure.