



Figure 1. Physical Photos of ALRS24V4R2AT

FEATURES

- Input Voltage Range: 90V ~ 264VAC
- Output Current: 4.2A
- High Efficiency: >83%
- Withstand 300VAC Surge Input for 5s
- Protections: Short Circuit/Overload/Over-voltage/Over Temperature
- Forced Air Cooling
- Built-in Cooling Fan On-Off Control
- 1U Low Profile
- Withstand 5G Vibration Test
- Wide Operating Temperature Range: $-10^{\circ}\text{C} \sim 60^{\circ}\text{C}$
- Protection Level: IP20
- PFC Function: NO

APPLICATIONS

The 100W single output switching power supply can be used in various applications that require a stable and efficient power supply. Here are some common applications:

1. Industrial automation equipment: Switching power supplies are commonly used in industrial automation equipment such as motor controllers, programmable logic controllers (PLCs), and robotic systems.
2. LED lighting: LED lighting requires a constant and stable power supply to function effectively. A 100W single output switching power supply can provide the necessary power to run LED lighting systems.
3. Telecom and networking equipment: Switching power supplies are widely used in telecom and networking equipment such as routers, switches, and modems.
4. Audio and video equipment: High-end audio and video equipment such as amplifiers, mixers, and video monitors require a stable power supply to ensure optimal performance.
5. Medical equipment: Medical equipment such as ultrasound machines, X-ray machines, and CT scanners require a reliable and stable power supply to ensure accurate readings and diagnoses.
6. Gaming systems: High-end gaming systems require a high-power output to run efficiently. A 100W single output switching power supply can provide the necessary power to run gaming systems.
7. Mining equipment: Cryptocurrency mining equipment requires a stable and efficient power supply to run continuously. A 100W single output switching power supply can be used to power mining equipment such as ASIC miners.

Overall, this 100W single output switching power supply is a versatile power supply that can be used in a wide range of applications that require a stable and efficient power supply.

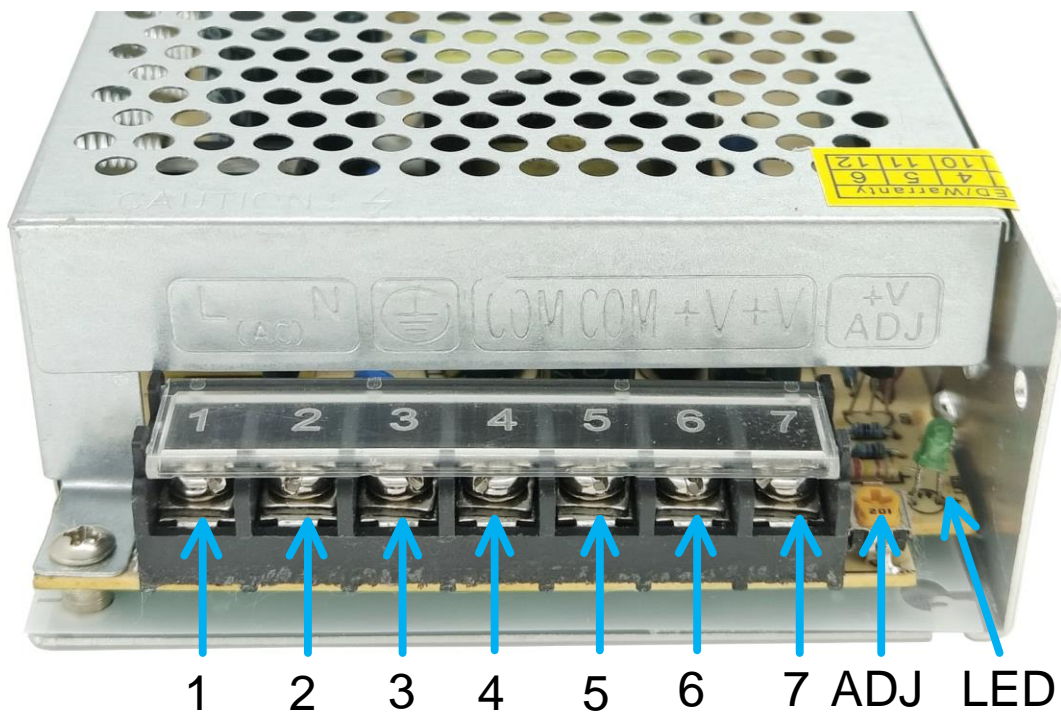

Table 1. Pin Names and Functions

| No. | Name | Description | Type |
|-----|---------|------------------------------------|-------------------------|
| 1 | L | Line terminal: AC Input Voltage | Power input |
| 2 | N | Neutral terminal: AC Input Voltage | Power input |
| 3 | FG | Power Ground | Ground for power supply |
| 4~5 | V-(COM) | Negative DC Output Voltage | Power output |
| 6~7 | V+ | Positive DC Output Voltage | Power output |
| ADJ | ADJ | Adjust the Output Voltage | Analog input |



DESCRIPTION AND SPECIFICATIONS

ALRS24V4R2AT is a highly efficient 100W single-output enclosed power supply with a 38mm low profile design. Equipped with a built-in long-life fan, this power supply can operate effectively at full load under temperatures ranging from -10°C to 60°C.

Not only does it offer high efficiency at over 83%, but it also comes with complete protection functions and 5G anti-vibration capability, ensuring reliability and safety in industrial applications. Moreover, it complies with international safety regulations, making it a top choice for a wide range of industrial applications.

Overall, the ALRS24V4R2AT power supply offers an ideal solution for industries seeking a compact, durable, and high-performance power supply that can operate in extreme conditions with complete safety and reliability.

Table 1. Specifications

| INPUT | | | | | | |
|-------------------------|---------------------------------|---|-------|------|-------|-------------------|
| Parameter | Symbol | Test Conditions | Min. | Typ. | Max. | Unit/Note |
| Input Voltage | V_{IN} | | 90 | | 264 | VAC |
| Input Voltage Accuracy | | | ±1 | | | % |
| Input Current | I_{IN} | $V_{IN}=100V$ | | 2 | | A |
| | | $V_{IN}=264V$ | | 0.76 | | A |
| Leakage Current | | $V_{IN}=260V$ | | | 0.5 | mA |
| Inrush Current | | $V_{IN}=100V$ | | 4.2 | | A |
| | | $V_{IN}=264V$ | | 2.1 | | A |
| OUTPUT | | | | | | |
| Parameter | Symbol | Test Conditions | Min. | Typ. | Max. | Unit/Note |
| Output Power | P | | | | 100 | W |
| Output Voltage | V_{OUT} | | 23.88 | 24 | 24.12 | V |
| Output Current | I_{OUT} | | 0 | | 4.2 | A |
| Output Voltage Accuracy | | | ±0.5 | | | % |
| Line Regulation | $\Delta V_{OUT}/\Delta V_{VPS}$ | Input voltage change: ±1% | -0.5 | | 0.5 | % |
| Load Regulation | $\Delta V_{OUT}/\Delta I_{OUT}$ | Load change from 10% to 100% | -0.5 | | 0.5 | % |
| Ripple & Noise | | | | | 120 | mV _{p-p} |
| Efficiency | η | | | 83 | | % |
| Temperature Coefficient | | Full Load @ 0 ~ 50°C | -0.03 | | 0.03 | %/°C |
| Over Load Protection | | Protection type: Shutdown the output voltage, Reset: Automatic Recovery | 105 | | 150 | % |



| GENERAL CHARACTERISTIC | | | | | | |
|-----------------------------------|------------|-----------------|----------------|-------|------|-----------|
| Parameter | Symbol | Test Conditions | Min. | Typ. | Max. | Unit/Note |
| Isolation Resistance | | | | 100 | | MΩ |
| Frequency | f_{sw} | | 50 | | 60 | Hz |
| Withstand Voltage | | | | 1.5 | | kVAC |
| Start Time | t_s | | | 200 | | ms |
| Rise Time | t_r | | | 50 | | ms |
| Hold Up Time | t_h | | | 20 | | ms |
| Operating Temperature Range | T_{opr} | | -10 | | 60 | °C |
| Operating Relative Humidity Range | RH_{opr} | | 20 | | 90 | % |
| Storage Temperature Range | T_{stg} | | -20 | | 85 | °C |
| Storage Relative Humidity Range | RH_{stg} | | 10 | | 95 | % |
| External Dimensions | | | 159×98×38 | | | mm |
| | | | 6.26×3.86×1.50 | | | inch |
| Weight | | | | 320 | | g |
| | | | | 0.71 | | lbs |
| | | | | 11.29 | | Oz |

Block Diagram

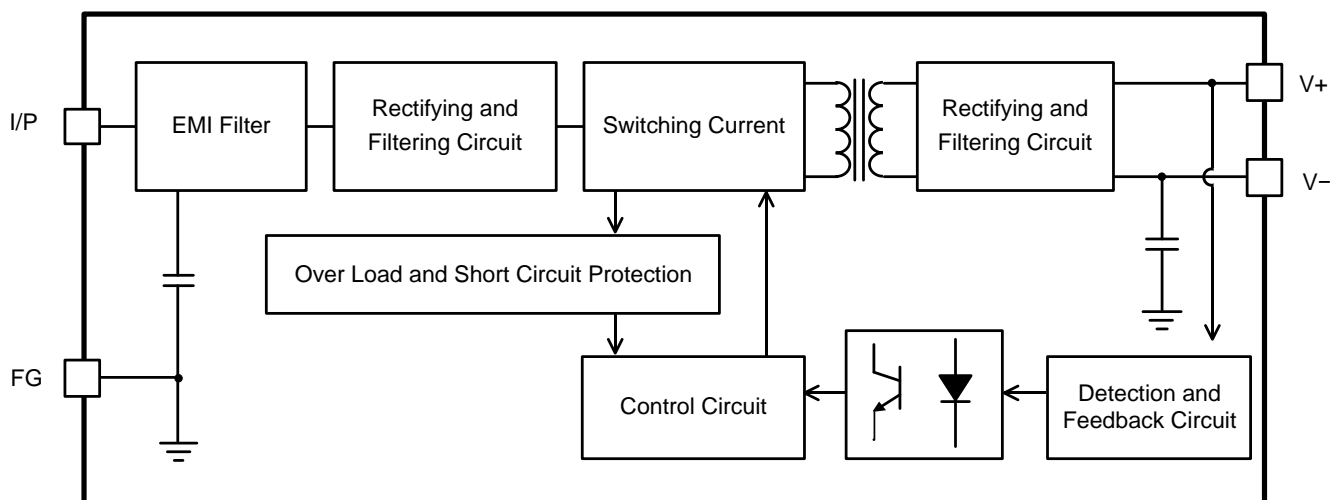

Figure 2. Power Supply Function Block Diagram



OUTLINE DIMENSIONS

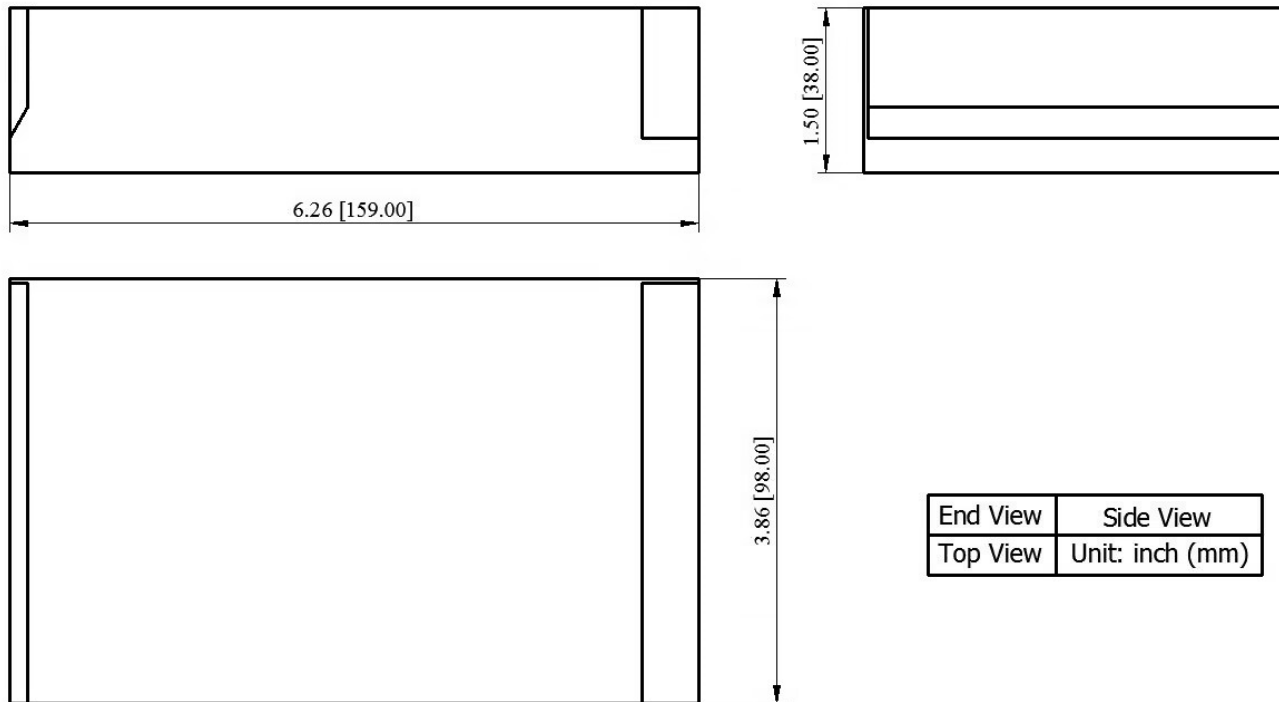

Figure 3. Outline Dimensions

NAMING CONVENTION

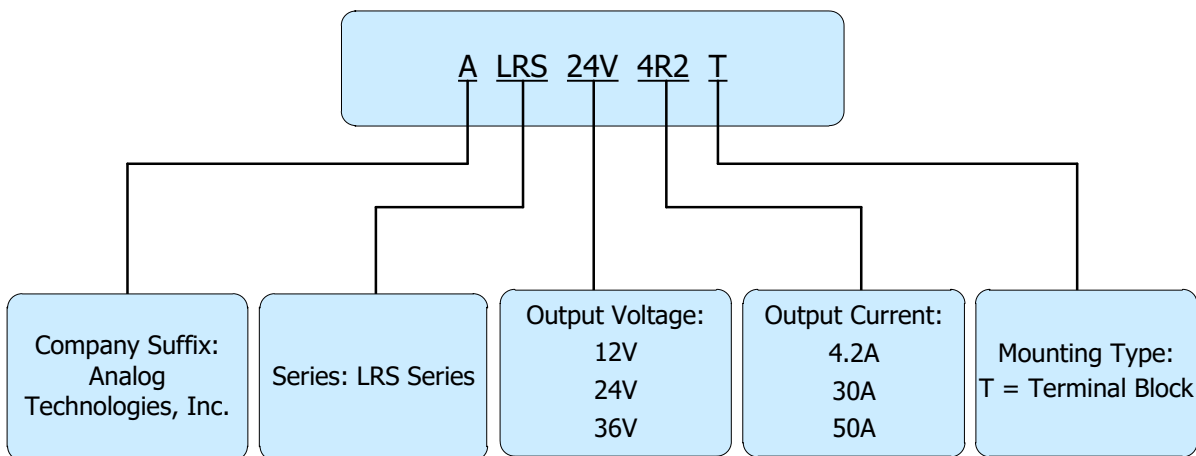



Figure 4. Naming Convention



ORDERING INFORMATION

| Part Number | Buy Now |
|--------------|---|
| ALRS24V4R2AT |  *  * |





































































*: both  and  are our online store icons. Our products can be ordered from either one of them with the same pricing and delivery time.

Table 4. ALRS24V4R2AT Families with Different Current

| Product Model | Input Voltage | Output Voltage | Output Current | Output Power | Datasheet | Buy Now* |
|---------------|---------------|----------------|----------------|--------------|---|---|
| | V | V | A | W | | |
| ALRS12V1R3AT | 90 ~ 264 | 12 | 1.3 | 15 |  |  *  * |
| ALRS12V2R2AT | 90 ~ 264 | 12 | 2.2 | 25 |  |  *  * |
| ALRS12V3AT | 90 ~ 264 | 12 | 3 | 36 |  |  *  * |
| ALRS12V5AT | 90 ~ 264 | 12 | 5 | 60 |  |  *  * |
| ALRS12V8R4AT | 90 ~ 264 | 12 | 8.4 | 100 |  |  *  * |
| ALRS12V10AT | 90 ~ 264 | 12 | 10 | 120 |  |  *  * |
| ALRS12V12R5AT | 90 ~ 264 | 12 | 12.5 | 150 |  |  *  * |
| ALRS12V15AT | 90 ~ 264 | 12 | 15 | 180 |  |  *  * |
| ALRS12V16R7AT | 90 ~ 264 | 12 | 16.7 | 200 |  |  *  * |
| ALRS12V20AT | 90 ~ 264 | 12 | 20 | 240 |  |  *  * |
| ALRS12V25AT | 90 ~ 264 | 12 | 25 | 300 |  |  *  * |
| ALRS12V30AT | 90 ~ 264 | 12 | 30 | 360 |  |  *  * |
| ALRS12V40AT | 90 ~ 264 | 12 | 40 | 480 |  |  *  * |
| ALRS12V50AT | 90 ~ 264 | 12 | 50 | 600 |  |  *  * |
| ALRS24VR65AT | 90 ~ 264 | 24 | 0.65 | 15 |  |  *  * |
| ALRS24V1R1AT | 90 ~ 264 | 24 | 1.1 | 25 |  |  *  * |
| ALRS24V1R5AT | 90 ~ 264 | 24 | 1.5 | 36 |  |  *  * |
| ALRS24V2R5AT | 90 ~ 264 | 24 | 2.5 | 60 |  |  *  * |
| ALRS24V4R2AT | 90 ~ 264 | 24 | 4.2 | 100 |  |  *  * |
| ALRS24V5AT | 90 ~ 264 | 24 | 5 | 120 |  |  *  * |
| ALRS24V7R5AT | 90 ~ 264 | 24 | 7.5 | 180 |  |  *  * |
| ALRS24V8R4AT | 90 ~ 264 | 24 | 8.4 | 200 |  |  *  * |



| Product Model | Input Voltage | Output Voltage | Output Current | Output Power | Datasheet | Buy Now* |
|---------------|---------------|----------------|----------------|--------------|-----------|----------|
| | V | V | A | W | | |
| ALRS24V10AT | 90 ~ 264 | 24 | 10 | 240 | | * * |
| ALRS24V12R5AT | 90 ~ 264 | 24 | 12.5 | 300 | | * * |
| ALRS24V15AT | 90 ~ 264 | 24 | 15 | 360 | | * * |
| ALRS24V20AT | 90 ~ 264 | 24 | 20 | 480 | | * * |

*Note: See Figure 4.

NOTICE

1. It is important to carefully read and follow the warnings, cautions, and product-specific notes provided with electronic components. These instructions are designed to ensure the safe and proper use of the component and to prevent damage to the component or surrounding equipment. Failure to follow these instructions could result in malfunction or failure of the component, damage to surrounding equipment, or even injury or harm to individuals. Always take the necessary precautions and seek professional assistance if unsure about proper use or handling of electronic components.
2. Please note that the products and specifications described in this publication are subject to change without prior notice as we continuously improve our products. Therefore, we recommend checking the product descriptions and specifications before placing an order to ensure that they are still applicable. We also reserve the right to discontinue the production and delivery of certain products, which means that not all products named in this publication may always be available.
3. This means that while ATI may provide information about the typical requirements and applications of their products, they cannot guarantee that their products will be suitable for all customer applications. It is the responsibility of the customer to evaluate whether an ATI product with the specified properties is appropriate for their particular application.
4. ATI warrants its products to perform according to specifications for one year from the date of sale, except when damaged due to excessive abuse. If a product fails to meet specifications within one year of the sale, it can be exchanged free of charge.
5. ATI reserves the right to make changes or discontinue products or services without notice. Customers are advised to obtain the latest information before placing orders.
6. All products are sold subject to terms and conditions of sale, including those pertaining to warranty, patent infringement, and limitation of liability. Customers are responsible for their applications using ATI products, and ATI assumes no liability for applications assistance or customer product design.
7. ATI does not grant any license, either express or implied, under any patent right, copyright, mask work right, or other intellectual property right of ATI.



8. ATI's publication of information regarding third-party products or services does not constitute approval, warranty, or endorsement.
9. ATI retains ownership of all rights for special technologies, techniques, and designs for its products and projects, as well as any modifications, improvements, and inventions made by ATI.
10. Despite operating the electronic modules as specified, malfunctions or failures may occur before the end of their usual service life due to the current state of technology. Therefore, it is crucial for customer applications that require a high level of operational safety, especially in accident prevention or life-saving systems where the malfunction or failure of electronic modules could pose a risk to human life or health, to ensure that suitable measures are taken. The customer should design their application or implement protective circuitry or redundancy to prevent injury or damage to third parties in the event of an electronic module malfunction or failure.