



Figure 1. Physical Photo of AHVACN10KV10MABT

FEATURES

- High precision
- High efficiency
- High output voltage stability
- Linear modulation of output voltage
- Overcurrent protection
- Short circuit protection
- Digital display for output voltage

APPLICATIONS

AHVACN10KV10MABT, is designed for achieving AC-DC conversion from AC voltage to high DC voltage. High voltage power supply is widely used in industrial measurement and control, energy spectrum analysis, and medical equipment such as: X-ray machine, vacuum/plasma processing, semiconductor fabrication equipment, analytical instrumentation, medical diagnostic and therapeutic systems, test equipment, and research and academic applications, etc.

DESCRIPTION

Connect AC 90~230V input, and then power on. When the potentiometer is in "0", open the high voltage switch, and then adjust the potentiometer clockwise. Observe the digital

display readings, and high voltage power supply output voltage = the reading \times 100V. When the required voltage is achieved, then rotate the potentiometer lock clockwise to lock the potentiometer. This prevents the output voltage changes caused by rotating the potentiometer by accident. High voltage connection wire is used for high voltage output.

SAFETY PRECAUTIONS

High voltage power supply must be connected to ground reliably.

Do not touch the high voltage wire, unless the high voltage power supply is powered off, and the load and internal capacitors are fully discharged.

When the high voltage power supply is powered off, wait for another 5 minutes for fully discharging all the capacitors inside the power supply.

Do not operate the power supply in humid environment, and do not connect the operator to ground.

The internal protection circuit is provided in the high voltage power supply, but the high voltage short circuit shall be avoided.

Make sure the circuit is insulated perfectly, especially between the high voltage output and the surroundings so as to avoid electronic shock.



SPECIFICATIONS

Table 1. Characteristics.

T_A = 25°C, unless otherwise noted

Parameter	Symbol	Condition	Min.	Typ.	Max.	Unit/Note
AC Input Voltage	V _{VPS}		90	110	230	V _{AC}
Quiescent Input Current	I _{INQQ}	I _{OUT} = 0mA	250	260	270	mA
Full Load Input Current	I _{INFLD}	I _{OUT} = 10mA	600	800	1200	mA
Input Voltage Regulation Ratio	$\Delta V_{OUT}/\Delta V_{VPS}$	V _{VPS} = 90V ~ 230V		0.05		%
Output Voltage	V _{OUT}	I _{OUT} = 0 ~ 10mA	0		-10000	V
Maximum Output Current	I _{OUTMAX}	V _{VPS} = 90V ~ 230V			10	mA
Ripple				<0.01		%V _{P-P}
Load				1		MΩ
Potentiometer Adjustment			10k potentiometer			
Output Modulation Linearity				<0.1		%
Load Regulation Rate		I _{OUT} = 0 ~ 10mA		≤0.05		%
Instantaneous Short Circuit Current	I _{SC}			<20		mA
Full Load Efficiency	η			≥70		%
Temperature Coefficient	TCV _O	-20 ~ 55°C		<0.01		%/°C
Time Drift	Short Time Drift	After 30 minute's warming up		<0.05		%/ min
	Long Time Drift			<0.05		%/h
Output Voltage Temperature Stability		-20 ~ 55°C		<±0.01		%
Operating Temperature Range	T _{opr}		-20		55	°C
Storage Temperature Range	T _{stg}		-20		80	°C
External Dimensions			350×300×125			mm
Weight				6000		g
				13.23		lbs
				211.64		Oz



PANEL INSTRUCTIONS

Front Panel



Figure 2. Front Panel

1. Display the output current: Digital display for the output current. Actual output current = the reading × mA.
2. Display the output voltage: Digital display for the output voltage. The actual output voltage = the reading × 100V.
3. Short circuit reset: When there is high voltage output short circuit, press the reset button to restart the unit.
4. High voltage ON/OFF switch
5. HV adjustment: 10-turn potentiometer for adjusting output voltage. Rotate it clockwise to increase the output voltage, and the potentiometer resistance = the corresponding scale × 10Ω. For example, as Figure 4 shows, when the scale is 10, and the frame above the scale shows 1 (1kΩ), then the resistance = 10×10Ω+1kΩ=1.1kΩ, and the like.

HV output: 1m long connection wire outputs -10kV 10mA.



Back Panel

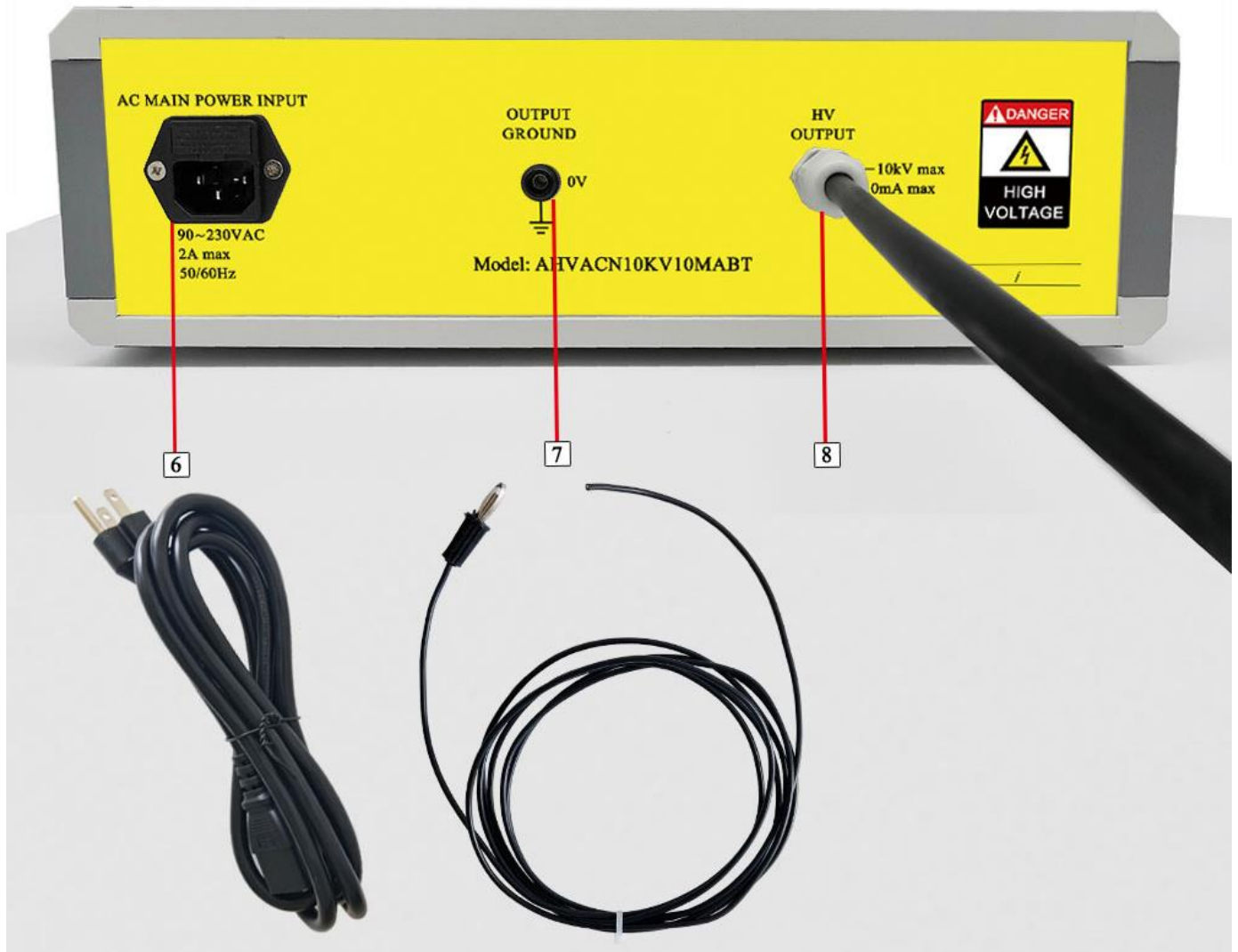

Figure 3. Back Panel

- 6. Input connector: AC input 90 ~ 230V 50/60Hz connector.
- 7. Output ground: high voltage power supply output ground terminal.
- 8. HV output: 1m long connection wire outputs -10kV and 10mA

*Note: The power supply unit is equipped with HV cables, a power cord, and a grounding wire as standard.



TESTING DATA

High voltage power supply testing data (Test condition: the load is 1MΩ)

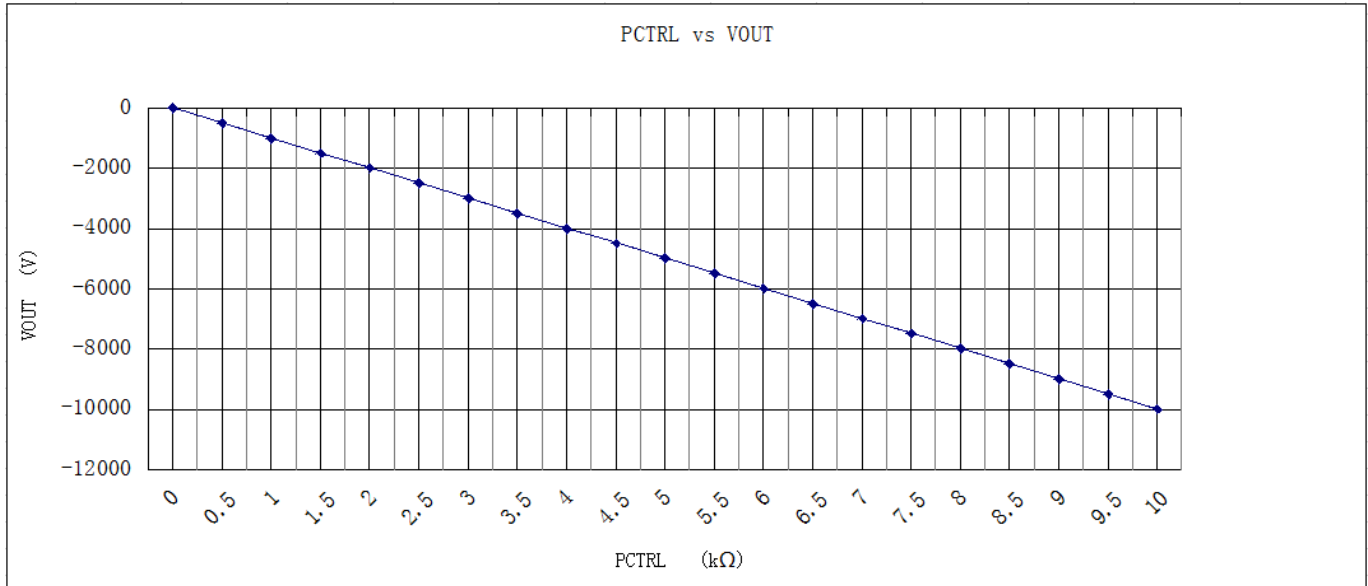

Figure 4. PCTRL vs. VOUT

NAMING INSTRUCTIONS

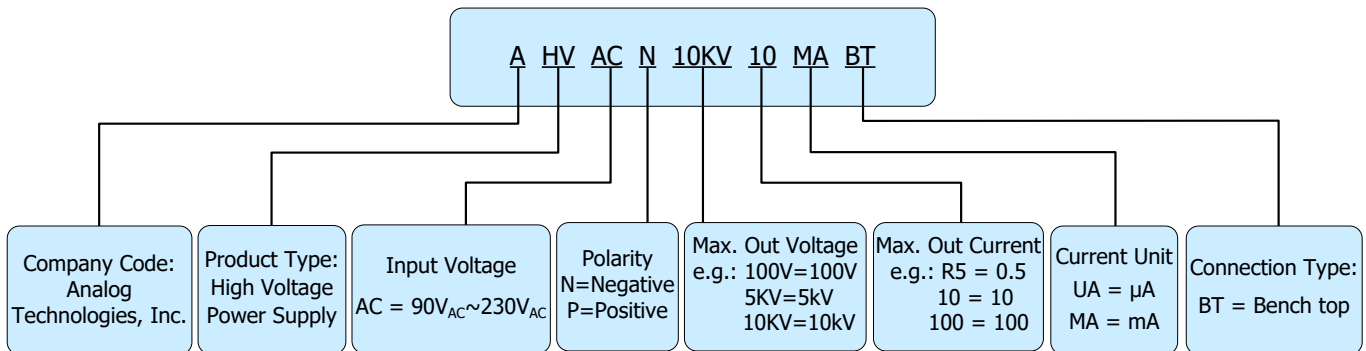

Figure 5. Naming Rules of AHVACN10KV10MABT



DIMENSIONS

I. Dimension of the leads.



Figure 6. Leads of AHVACN10KV10MABT

Leads	Diameter (mm)	Length (m)
Thick brown lead	4.5	1.0
Power cord	6.5	1.8

II. Dimension of AHVACN10KV10MABT.

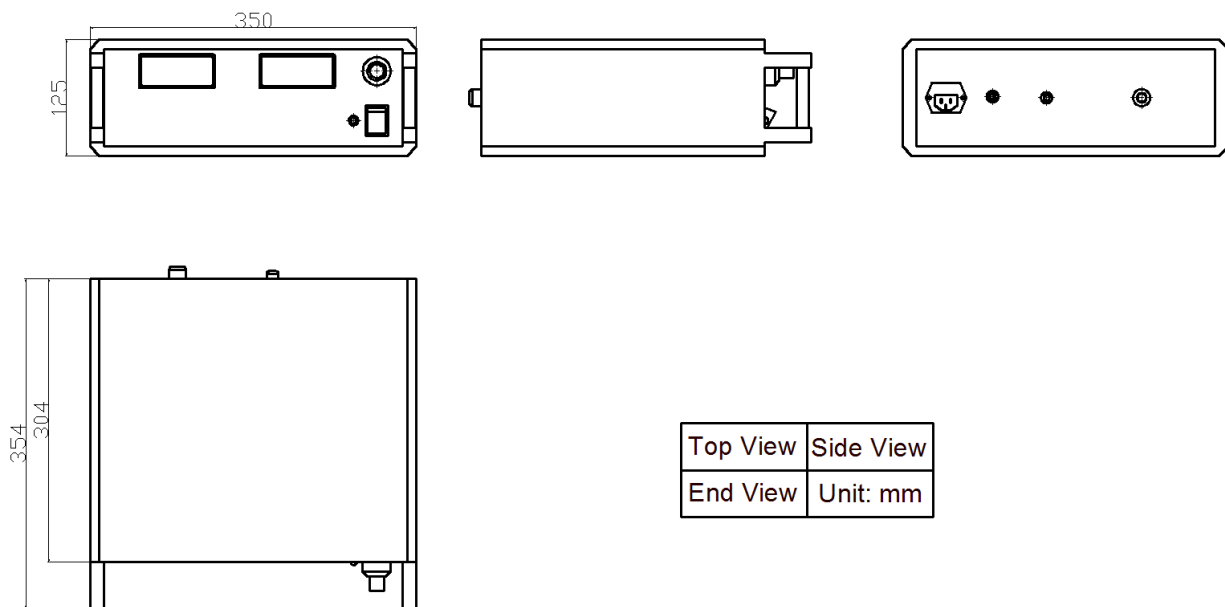





Figure 7. Dimensions for AHVACN10KV10MABT



ORDERING INFORMATION

Part Number	Buy Now
AHVACN10KV10MABT	 *  *

*: both  and  are our online store icons. Our products can be ordered from either one of them with the same pricing and delivery time.

NOTICE

1. It is important to carefully read and follow the warnings, cautions, and product-specific notes provided with electronic components. These instructions are designed to ensure the safe and proper use of the component and to prevent damage to the component or surrounding equipment. Failure to follow these instructions could result in malfunction or failure of the component, damage to surrounding equipment, or even injury or harm to individuals. Always take the necessary precautions and seek professional assistance if unsure about proper use or handling of electronic components.
2. Please note that the products and specifications described in this publication are subject to change without prior notice as we continuously improve our products. Therefore, we recommend checking the product descriptions and specifications before placing an order to ensure that they are still applicable. We also reserve the right to discontinue the production and delivery of certain products, which means that not all products named in this publication may always be available.
3. This means that while ATI may provide information about the typical requirements and applications of their products, they cannot guarantee that their products will be suitable for all customer applications. It is the responsibility of the customer to evaluate whether an ATI product with the specified properties is appropriate for their particular application.
4. ATI warrants its products to perform according to specifications for one year from the date of sale, except when damaged due to excessive abuse. If a product fails to meet specifications within one year of the sale, it can be exchanged free of charge.
5. ATI reserves the right to make changes or discontinue products or services without notice. Customers are advised to obtain the latest information before placing orders.
6. All products are sold subject to terms and conditions of sale, including those pertaining to warranty, patent infringement, and limitation of liability. Customers are responsible for their applications using ATI products, and ATI assumes no liability for applications assistance or customer product design.
7. ATI does not grant any license, either express or implied, under any patent right, copyright, mask work right, or other intellectual property right of ATI.
8. ATI's publication of information regarding third-party products or services does not constitute approval, warranty, or endorsement.
9. ATI retains ownership of all rights for special technologies, techniques, and designs for its products and projects, as well as any modifications, improvements, and inventions made by ATI.
10. Despite operating the electronic modules as specified, malfunctions or failures may occur before the end of their usual service life due to the current state of technology. Therefore, it is crucial for customer applications that require a high level of operational safety, especially in accident prevention or life-saving systems where the malfunction or failure of



electronic modules could pose a risk to human life or health, to ensure that suitable measures are taken. The customer should design their application or implement protective circuitry or redundancy to prevent injury or damage to third parties in the event of an electronic module malfunction or failure.