



Figure 1. Physical Photos of AHVA250V2X10MA

MAIN FEATURES

- Built-in High Voltage Converter
- Compact Size: 176.5(L)×147.0(W)×41.2(H) mm
- High Current Capability: Up to 10mA
- High Slew Rate: 250V/μs
- Wide Output Voltage Range: $V_{OUT}=0\sim 250V@V_{IN}=24V$

Table 1. Descriptions of Terminal Block Pin Functions

Pin #	Name	Type	Description
1	VPS	Power Input	Power supply 24V.
2	PGND	Power Ground	Power ground pin.
3	SBDN	Digital Input	This is a duplex pin. It sets the amplifier into Off, Standby or On mode.
4	AGND	Signal Ground	Signal ground pin. Connect ADC and DAC grounds to here.
5	10VR	Analog Output	10V voltage reference.
6	IHVMON	Analog Input	-
7	HVMON	Analog Output	Output voltage indication. When going from 0 to 10V, it indicates the output voltage is from 0 to 250V.
8	OFFSO	Analog Input	Output voltage setting. When going from 0 to 10V, it indicates the output voltage is from 0 to 250V. The pin is controlled by a potentiometer.
9	GND	Signal Ground	Signal ground pin. Connect ADC and DAC grounds to here.

- Offset Voltage Range: 10V
- Bandwidth: Up to 500kHz
- Weight: 2.2lb (1.0kg)

APPLICATIONS

High voltage amplifications for driving piezos and other high voltage loads.

DESCRIPTION

The AHVA250V2X10MA is an electronic module for amplifying an analog input voltage into a high voltage output. Figure 1 shows its physical photo. It comes with a high voltage DC-DC converter, which converts the 24V input voltage into a 0 to 250V output voltage. The analog output voltage can swing almost from 0 to 250V when it is powered by a 24V power supply. There is three LEDs indicating if the amplifier works properly.

CAUTION

First, set up the AC power supply and fix it stably and firmly. Then make sure that the two switches of the high voltage amplifier are OFF. Connect the 24V DC power supply to the VPS and PGND of the high voltage amplifier. After the connection is complete, turn on the low voltage switch and set the input AC voltage or DC voltage. Then use the output monitor to check whether the input set voltage is correct. Finally turn on the high voltage switch.



Pin #	Name	Type	Description
BNC 1	INPUT	Analog Input	Output voltage setting. When going from 0 to 10V, it indicates the output voltage is from 0 to 250V.
BNC 2	INPUT+DC	Analog Input	INPUT+DC input control signal indication.
BNC 3	VOUT	Analog Output	Output voltage for driving the load.
	OGND	Output Ground	Connect this pin to the load return terminal.

SPECIFICATIONS

Table 2. Characteristics (Test ambient temperature $T_A = 25^\circ\text{C}$)

Parameter	Symbol	Test Conditions	Min.	Typ.	Max.	Units
Power Supply Input						
Input Range	V_{VPS}		23	24	25	V
Input Current	I_{IN}		0		4	A
Voltage Output						
Output Voltage	V_{OUT}		0		250	V
Output Current	I_{OUT}		0		10	mA
SBDN Pin (Pin 3)						
SBDN Voltage	$V_{SBDN-ON}$		2.64		V_{VPS}	V
	$V_{SBDN-STANDBY}$		2.1		2.5	V
	$V_{SBDN-OFF}$		0		0.4	V
	$V_{SBDN-SB-HI}$ Going up from Standby to On threshold voltage		2.508		2.64	V
	$V_{SBDN-SB-LOW}$ Going down from On to Standby threshold voltage		2.5		2.6	V
	$V_{SBDN-OFF-HI}$ Going up from Off to Standby threshold voltage				2.1	V
	$V_{SBDN-OFF-LOW}$ Going down from Standby to Off threshold voltage		0.4			V
SBDN Current	I_{SBDN}			10	20	μA
10VR Pin (Pin 5)						
Voltage Reference	V_{REF}			10		V
Maximum Input Power				10		W
Maximum Slew Rate				100		V/ μs

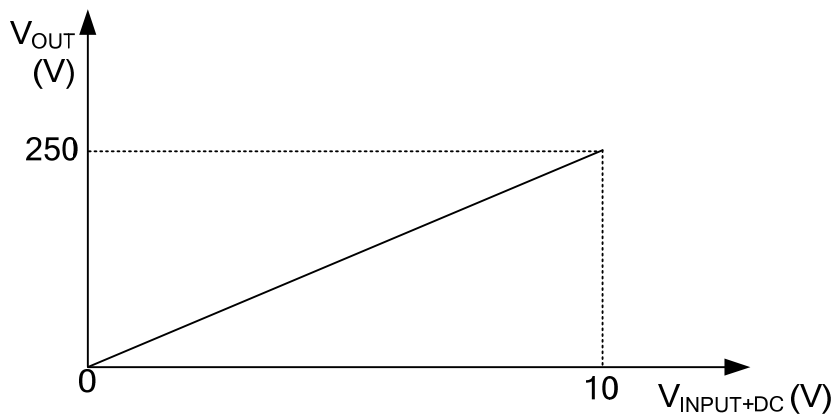

Figure 2. V_{OUT} vs. V_{VIN}

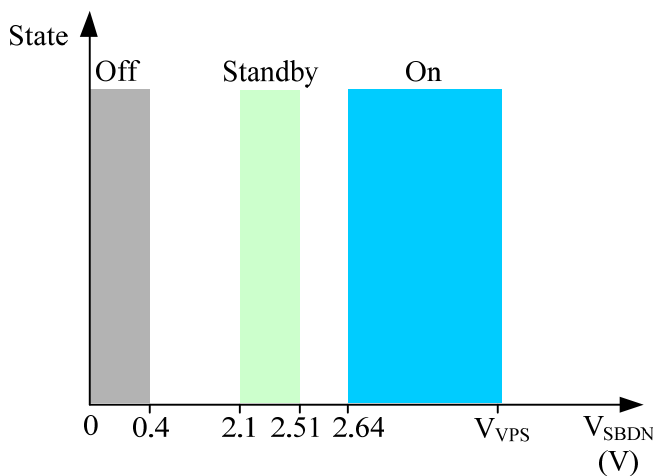
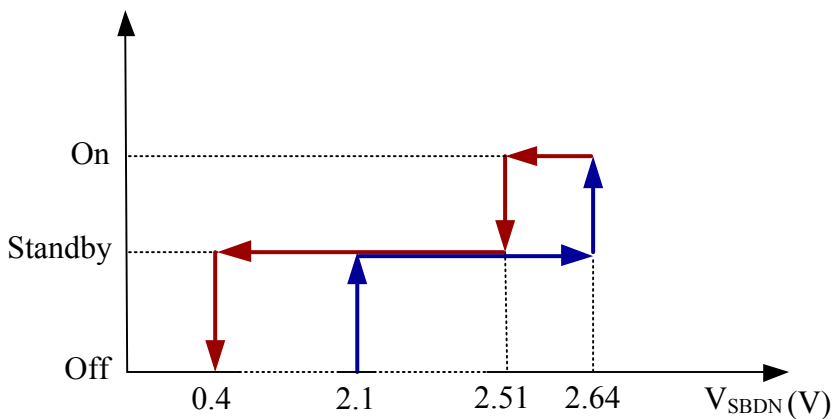

Figure 3. The States of Amplifier vs. V_{SBDN}

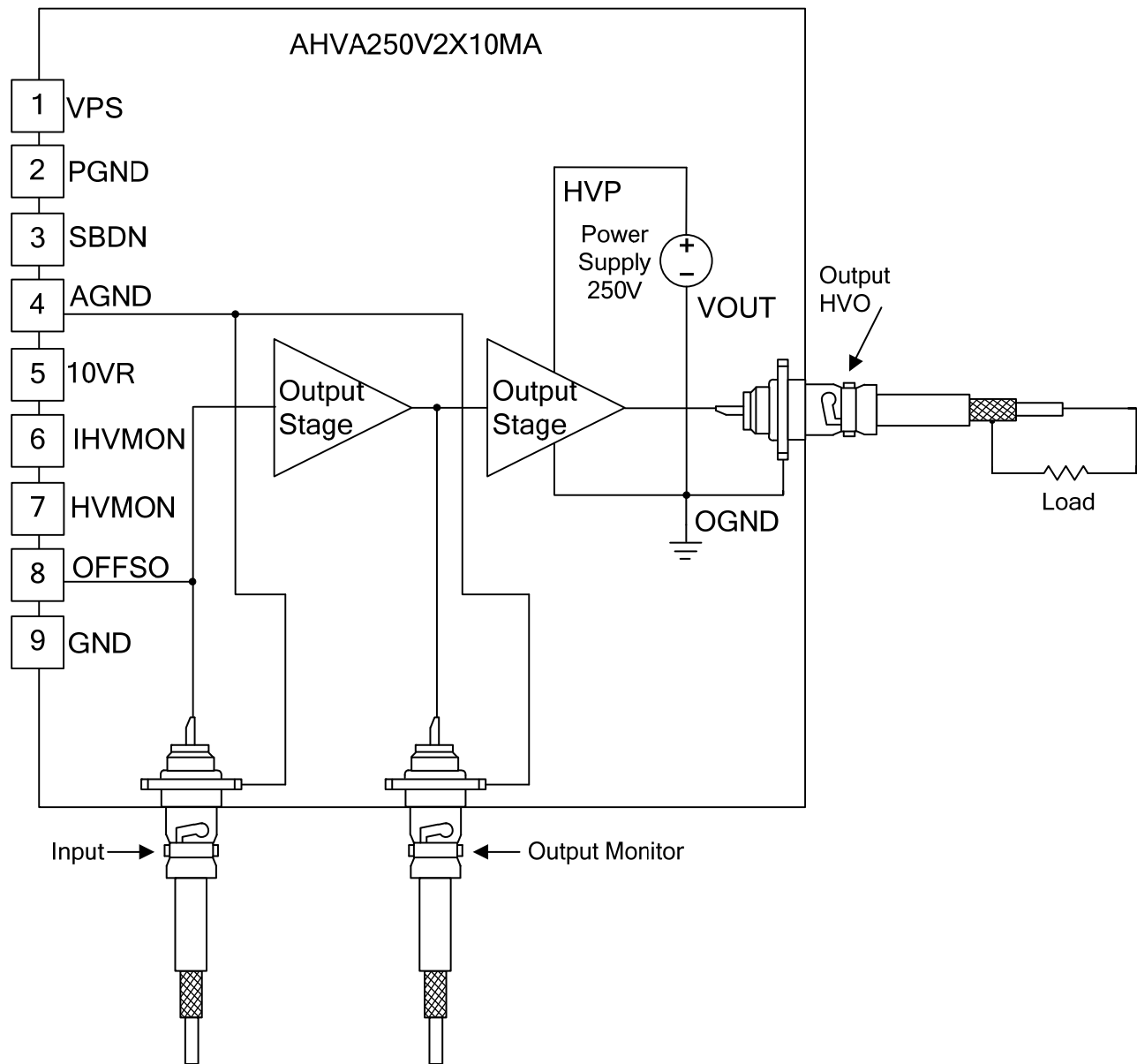

Figure 4. Schematic for Driving the Load

As shown in Figure 5 and Figure 6, when a square wave of 0V ~ 10V, $f=100\text{Hz}$, is applied to AC input pin, measure the waveform of HVO. The rise time should be about $10\mu\text{s}$, and the fall time should be about $11\mu\text{s}$.

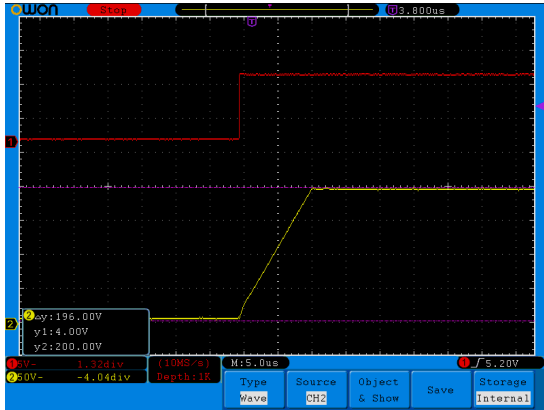

Figure 5. Rise Time

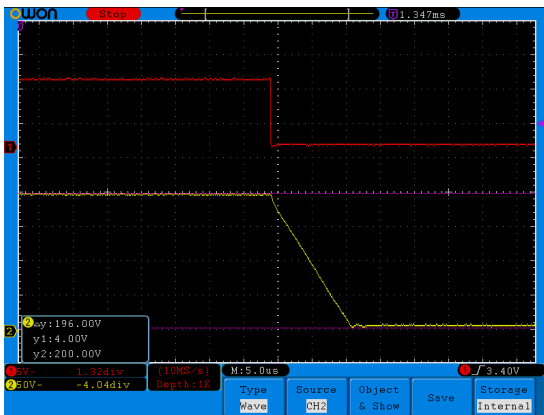

Figure 6. Fall Time

As shown in Figure 7 ~ Figure 10, when a sine wave of 0V ~ 10V, $f=100\text{Hz}/10\text{kHz}/20\text{kHz}/35\text{kHz}$, is applied to AC input pin, measure the waveform of HVO. Gain=200.

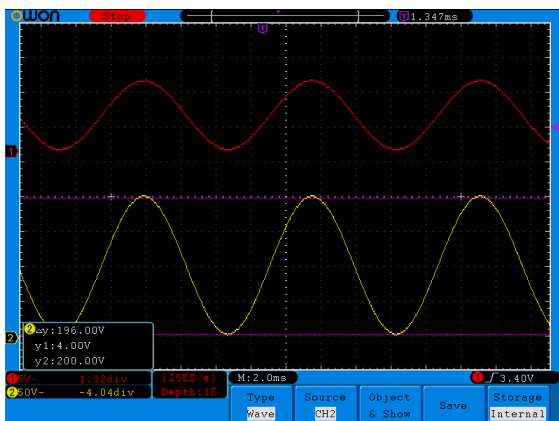

Figure 7. $f=100\text{Hz}$

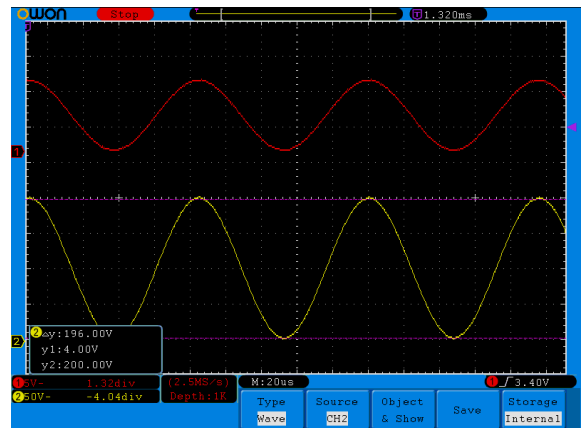

Figure 8. $f=10\text{kHz}$

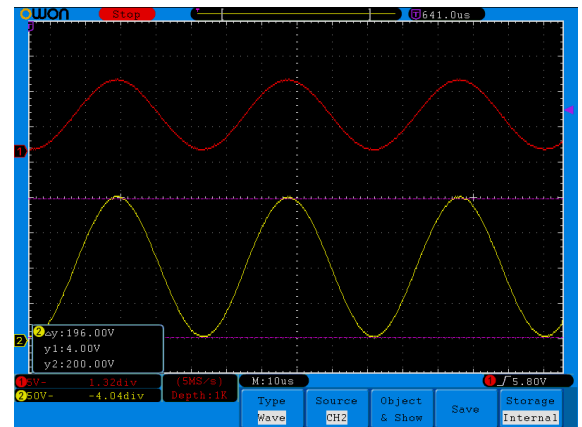

Figure 9. $f=20\text{kHz}$

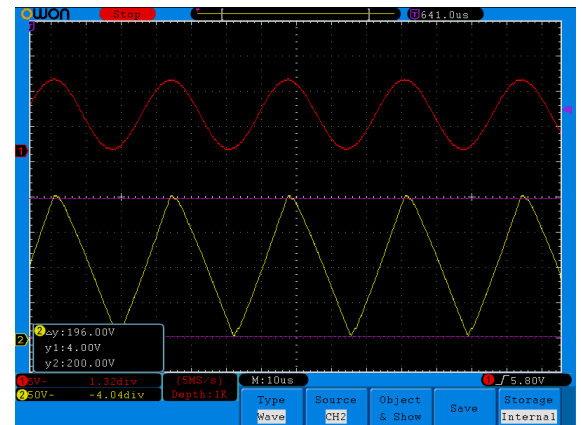

Figure 10. $f=35\text{kHz}$

As shown in Figure 11, when a sine wave of 0V ~ 10V, $f=50\text{kHz}$, is applied to AC input pin, measure the waveform of HVO. Gain = 140.

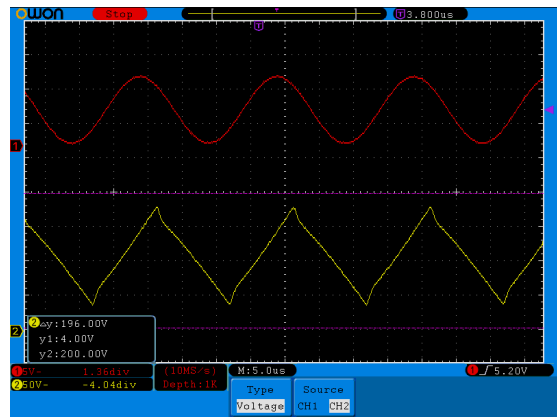

Figure 11. $f=50\text{kHz}$

BLOCK DIAGRAM

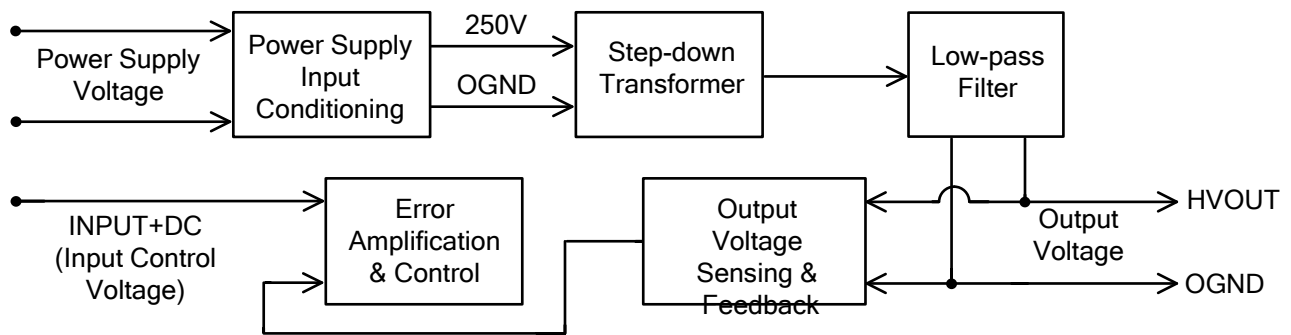
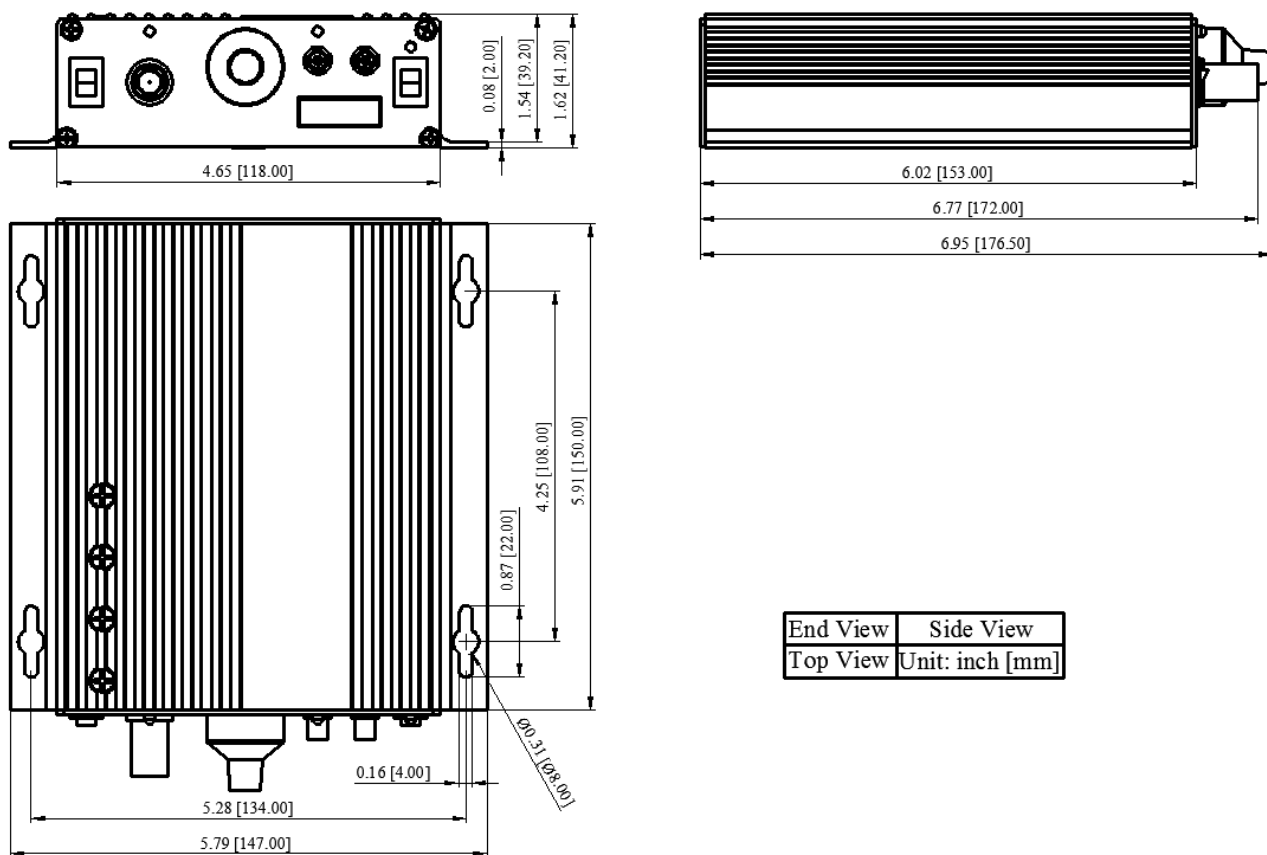

Figure 12. Block Diagram



DIMENSIONS



End View	Side View
Top View	Unit: inch [mm]

Figure 13. Dimensions of AHVA250V2X10MA

ORDERING INFORMATION

Table 3. Part Number

Part Number	Description
AHVA250V2X10MA	250V high voltage amplifier



NOTICE

1. ATI warrants performance of its products for one year to the specifications applicable at the time of sale, except for those being damaged by excessive abuse. Products found not meeting the specifications within one year from the date of sale can be exchanged free of charge.
2. ATI reserves the right to make changes to its products or to discontinue any product or service without notice, and advise customers to obtain the latest version of relevant information to verify, before placing orders, that information being relied on is current and complete.
3. All products are sold subject to the terms and conditions of sale supplied at the time of order acknowledgment, including those pertaining to warranty, patent infringement, and limitation of liability. Testing and other quality control techniques are utilized to the extent ATI deems necessary to support this warranty. Specific testing of all parameters of each device is not necessarily performed, except those mandated by government requirements.
4. Customers are responsible for their applications using ATI components. In order to minimize risks associated with the customers' applications, adequate design and operating safeguards must be provided by the customers to minimize inherent or procedural hazards. ATI assumes no liability for applications assistance or customer product design.
5. ATI does not warrant or represent that any license, either express or implied, is granted under any patent right, copyright, mask work right, or other intellectual property right of ATI covering or relating to any combination, machine, or process in which such products or services might be or are used. ATI's publication of information regarding any third party's products or services does not constitute ATI's approval, warranty or endorsement thereof.
6. IP (Intellectual Property) Ownership: ATI retains the ownership of full rights for special technologies and/or techniques embedded in its products, the designs for mechanics, optics, plus all modifications, improvements, and inventions made by ATI for its products and/or projects.