

Figure 1. Front View of the AAS50A6V3



Figure 2. Top View of the AAS50A6V3

FEATURES

- High Efficiency: $\geq 70\%$
- Maximum Power: 300W
- Maximum Output Current: 50A
- Wide Output Voltage: 0V ~ 6V
- Wide Input Voltage: 100VAC ~ 240VAC
- High Speed Digital Modulation: 5kHz
- Configurable Valley Current for Digital Modulation
- Low Temperature Rise: 30°C
- Over-temperature Protection
- MBTF (Mean Time Before Failure): 180,000 hours
- Low Corner Noise at 0.1 ~ 10Hz: 354 μ A_{P-P}
- Low Ripple Voltage at 600kHz: <10mV_{P-P}
- Compact Size
- Low Cost
- 100 % Lead (Pb)-free and RoHS Compliant

APPLICATIONS

Driving high current laser diode bars with high stability and high efficiency.

DESCRIPTIONS

The AAS50A6V3 is an electronic power supply brick designed for driving laser diodes with up to 50A low noise current. The output current can be set by an analog voltage of 0V to 2.5V, an external potentiometer, or the built-in internal potentiometer, to between 0 and 50A.

A pulsed output current can be generated by driving the PCN port with a digital signal, under which, the peak output current is set by the LISH port while the valley output current is set by the LISL port. The modulation frequency can go up to 5kHz, resulting to an approximately 56 μ S rise/fall time at the output current.

The AAS50A6V3 laser driver comes with a high stability low noise 2.5V reference voltage. It can be used for setting the output current. This reference can also be used as the voltage reference for external ADCs (Analog to Digital Converters) and DACs (Digital to Analog Converters), which might be used for monitoring and/or setting the laser current.

This laser driver brick has a high efficiency: $\geq 70\%$ @ $V_{LDA} = 5.5V$, $I_{OUT} = 50A$. It saves energy and has low temperature rise.

There is an over-temperature protection circuit inside, in case the laser power supply temperature exceeds the temperature limit, 85°C, the laser driver will shut down itself and be turned back on by itself after the temperature returns to the normal temperature range.

There is a soft-start circuit in this laser driver, which ensures smooth current transactions during power-up period.

In case there is a short circuit at the output, the internal protection circuit will cut off the output.

The output voltage is automatically set from 0V to 6V to keep the output current at a pre-set value. When the output voltage exceeds the maximum value, the driver will not works properly.

The control loop is monitored in real time by an internal circuit, to make sure that it works properly. The monitoring result is sent to the LPGD node. When this pin is pulled up internally, it indicates that the control loop works properly and Loop Good LED will be lit. This pin signal can be sent to a microcontroller, or used for driving an LED through a buffer. The internal equivalent circuit of this pin is a 5k Ω pull-up resistor connected to a 5V rail in parallel with an open drain comparator output.

The main specifications are shown in Table 1.



Table 1. Specifications (T_A = 25°C)

Parameter	Symbol	Test Conditions	Min.	Typ.	Max.	Unit
Efficiency	η	V _{IN} =110VAC, V _{OUT} =3.5V, I _{OUT} =50A	—	70	—	%
Power	P				300	W
Output Current	I _{OUT}	V _{OUT} =0V to 6V	0	Adjustable	50	A
Current Accuracy	%	-20°C ~ 50°C	—	±0.5	—	%
Input Voltage	V _{IN}		88	110 or 220	264	VAC
Input Frequency	f _{IN}		47	50 or 60	63	Hz
Output Voltage	V _{OUT}		0	Adaptive	6	V
Ripple Voltage	V _{RIP} (600kHz)	V _{IN} =110VAC, V _{OUT} =2.5V, I _{OUT} =20A	6	8	10	mV _{P-P}
Output Current Noise	I _{ON} (0.1-10Hz)	V _{IN} =110VAC, V _{OUT} =2.5V, I _{OUT} =20A, RS=0.1Ω, f=0.1Hz to 10Hz	348	354	360	μA _{P-P}
Operating Temperature	T _A		-20	25	50	°C

CONNECTOR FUNCTIONS

The laser driver AAS50A6V3 has 2 connectors, Con1 on the left side, a standard 15 pin female D-SUB connector, and Con2 on the right side, a 6 conductor terminal block, as shown in Figure 1 and Figure 28. The Con1 is for connecting control and monitor signals, and the Con2 is for connecting to the laser diode. A typical connection schematic is shown in Figure 3 below.

APPLICATION INFORMATION

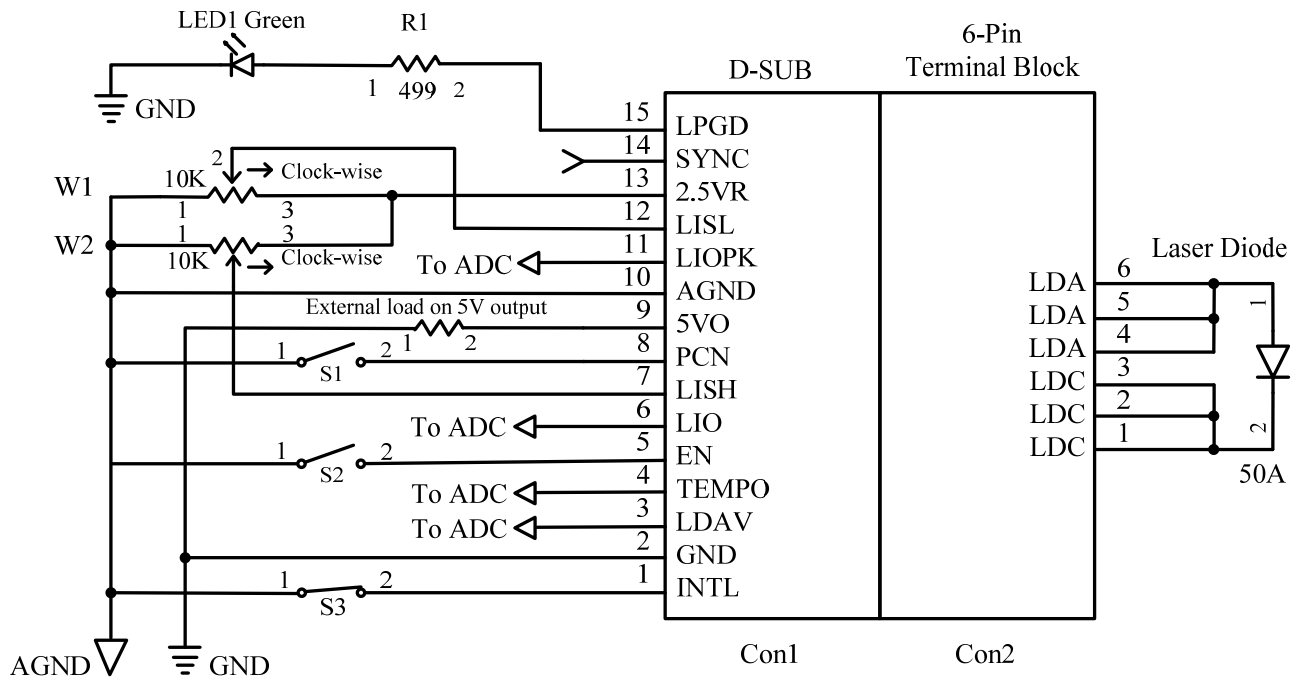

Figure 3. A Typical Application Schematic



The functions of all the pins in Con1 are described in Table 2 below.

Table 2. Pin Function Description for Con 1 and Con 2 Connectors

Pin Number	Name	Meaning	Type	Description	
Con 1 (D-Sub)	1	INTL	Interlock	Digital input	Connect to one or a series of safety interlock switches. Open circuit=laser driver off, short to AGND= laser driver on.
	2	GND	Ground	Power ground	Connect power grounds here.
	3	LDAV	Indication for the output voltage on the laser diode	Analog output	It equals to half value of the voltage applied to the laser diode anode. The internal resistance is 10kΩ.
	4	TEMPO	Laser driver internal temperature indication	Analog output	Its voltage proportional to the temperature of the driver. See section C for details.
	5	EN	Enable	Digital input	Internally pulled up to 5V by a 100kΩ resistor. Pulling this pin to AGND will disable the driver.
	6	LIO	Laser current indication	Analog output	An output voltage of 0 to 2.5V at this pin indicates the output current into the laser is between 0 to 50A linearly.
	7	LISH	Laser current setting port for PCN=1	Analog input	Setting this pin's voltage from 0V to 2.5V sets the output current from 0 to 50A linearly when PCN=1. This pin can be set by an external analog signal source, POT, or DAC. Input impedance is 20kΩ. When modulating the laser by a digital signal through the PCN pin, this pin sets the output peak current.
	8	PCN	Pulse control	Digital input	Pulse Control input. This pin toggles the laser output current to change between the pre-set two values: a low value set by the LISL pin @ PCN= 0V ~ 0.4V and a high value set by the LISH pin @ PCN= 2.6V ~5V. This PCN pin is pulled high to an internal 5V rail by a 100kΩ resistor. Between 0V~ 5V, the pull up resistor causes most of the current on this pin, the electronic switch current is < ±0.1μA. The maximum voltage on this pin is 5.5V. The rise and fall time of the output is 56uS when PCN pin is toggled between low and high.
	9	5VO	Power supply voltage	Power output	A 5V DC power supply output, maximum output current is 200mA.
	10	AGND	Analog ground	Signal ground	Connect ADC and DAC, POT and/or signal source grounds here.
	11	LIOPK	Laser current peak value indication	Analog output	This pin's voltage is proportional to the peak value of the output current going through the laser diode. An output voltage of 0 to 2.5V represents a peak output current of 0 to 50A linearly.
	12	LISL	Laser current setting port for PCN=0	Analog input	Setting this pin's voltage from 0V to 2.5V sets the output current form 0 to 50A linearly when PCN=0. This pin can be set by a built-in internal POT or an external analog signal source, POT, or a DAC. Input impedance is 20kΩ. When modulating the laser by a digital signal through the PCN pin, this pin sets the output valley current.



	13	2.5VR	Reference voltage	Analog output	A 2.5V reference voltage. It can be used as a reference voltage for setting the output current using external POTs or DACs. It can also be used by an ADC to measure the output analog voltages for monitoring the output parameters.
	14	LPGD	Loop good indication	Digital output	This pin is pulled up by a 5kΩ resistor to the 5V. When being high, the control loop is working properly, otherwise, not properly.
	15	SYNC	Synchronization input	Digital input	The driver synchronizes on the falling edge of a square wave signal applied to this pin. The peak voltage of the square wave should be higher than 2.5V but lower than 7V. And the valley voltage of the square wave should be less than 1V. The frequency of the square wave should be between 500kHz and 600kHz.
Con2 (6 pin terminal block)	1, 2 & 3	LDC	Laser diode cathode	Power output	Connect it to the cathode of the laser diode.
	4, 5 & 6	LDA	Laser diode anode	Power output	Connect it to the anode of the laser diode.

Table 3. Copper wire specification

Specification	Wire Diameter	Carrying Capacity
1.0mm ²	1.13mm	14A 17A
1.5mm ²	1.39mm	21A 23A
2.5mm ²	1.79mm	28A 32A
4.0mm ²	2.25mm	37A 48A
6.0mm ²	2.76mm	48A 60A
10.0mm ²	3.57mm	65A 90A
16.0mm ²	4.52mm	91A 100A

A. Analog Modulation

When needing the driver to output constant current, we should set PCN pin for modulation. We can set PCN high or unconnected, and the output current will be between 0A and 50A linearly by setting LISH pin from 0V to 2.5V.

We can also set PCN low, and the output current will be between 0A and 50A linearly by setting LISL pin from 0V to 2.5V.

The Input Control Switch is the modulation type selector switch. When needing analog modulation, dial the switch to the lower side. And dial the switch to the upper side for digital modulation.

B. Digital Modulation

When needing digital modulation, i.e., on and off control, use PCN pin for controlling output current. When PCN is high, the output current, the peak current, is determined by LISH pin; when PCN is low, the output current, the valley current, is determined by LISL pin. The threshold voltage of PCN pin is about 2.5V, but don't exceed 5V. The maximum modulation frequency is 5kHz. See Figure 4.

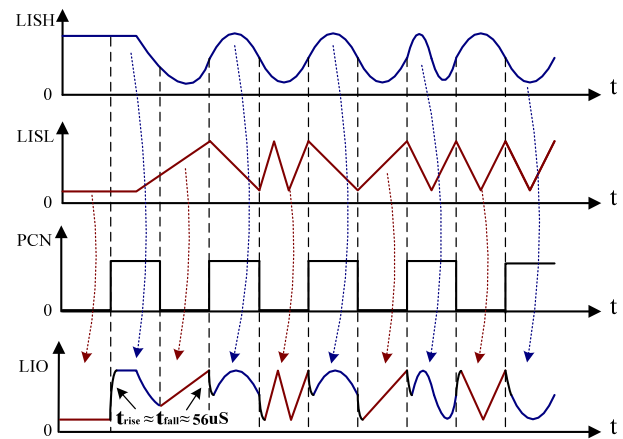

Figure 4. Digitally Controlled Analog Modulation Principle

The LISL pin sets the valley current to be between 0A to 50A by setting LISL pin voltage to between 0V to 2.5V linearly; LISH pin sets the peak current to be between 0A to 50A when setting this pin's voltage to between 0V to 2.5V linearly.

The output current formula is:

Peak current $I_{OUT} (A) = 20 \times V_{LISH} (V)$

Valley current $I_{OUT} (A) = 20 \times V_{LISL} (V)$

2.5VR pin can be used as a 2.5V power supply, the maximum output current is 20mA.

LIO pin or LIOPK pin indicates the output current:

Output current $(A) = 20 \times V_{LIO} (V)$



LIO represents the instant laser current, while LIOPK is the peak current. When the modulation speed exceeds 3kHz, LIOPK will not have the function of indication.

Figure 5 is the mathematic model of the LIOPK's waveform. It's an exponential function, and see the practical waveform in Figure 9.

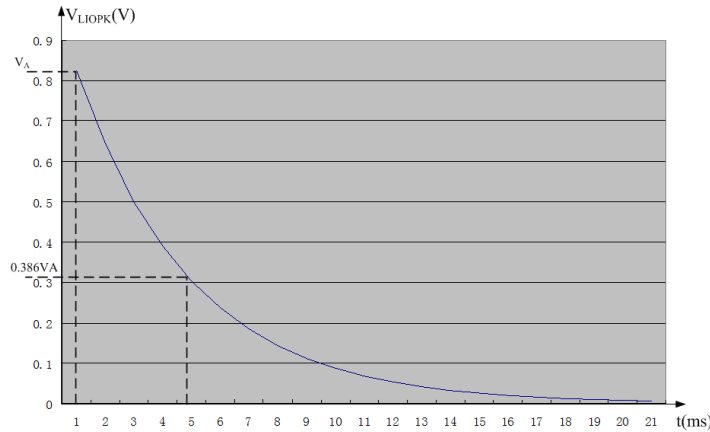

Figure 5. LIOPK's Mathematic Model

Attenuation speed formula of LIOPK's waveform is:

$$V_{LIOPK}(t) = V_A e^{-\frac{t}{100ms}}$$

V_A is the peak voltage of V_{LIOPK} .

Peak output current (A) = $20 \times V_{LIOPK}$ (V)

Digital Modulation Response Waveforms

When the input PCN is a 100Hz digital signals, the response waveform measured at LDA pin is shown in Figure 6 and the rise and fall time is approximately 56 μ S. The waveform changes from 0.8V to 1.8V and scanning speed is 50 μ s/D. Figure 7 shows the same waveform with slower scanning speed: 2ms/D.

When the input PCN is a 5kHz digital signal, measured output at LDA pin is shown in Figure 8, the voltage changes from 0.78V to 1.89V and scanning speed is 50 μ s/D.

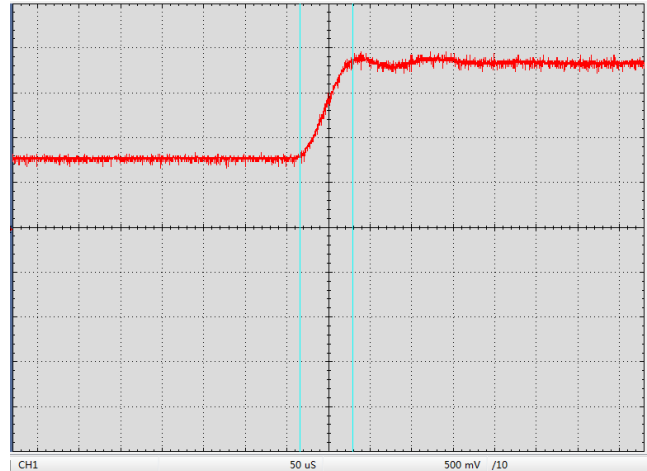

Figure 6. Digital Modulation Response at LDA Pin

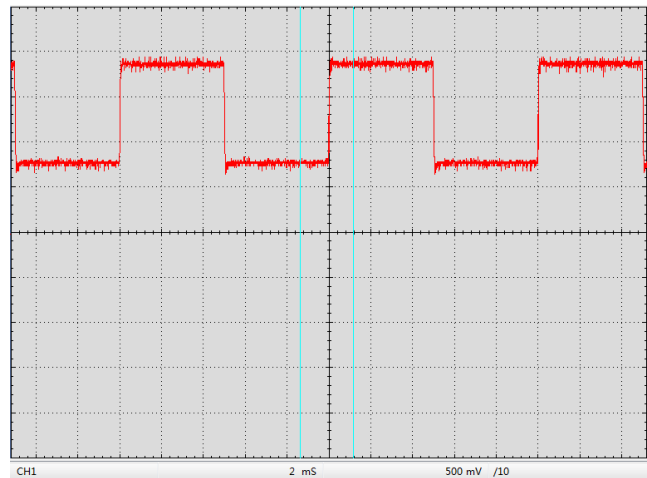

Figure 7. Digital Modulation Response at LDA Pin

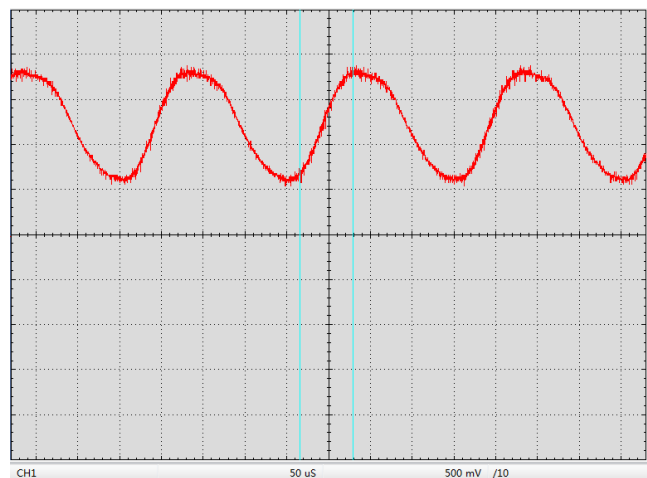

Figure 8. Digital Modulation Response at LDA Pin

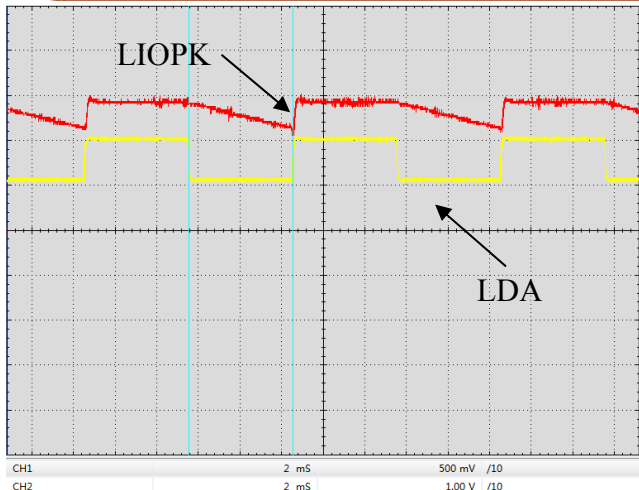

Figure 9. Digital Modulation Response at LIOPK & LDA Pin (f= 100Hz)

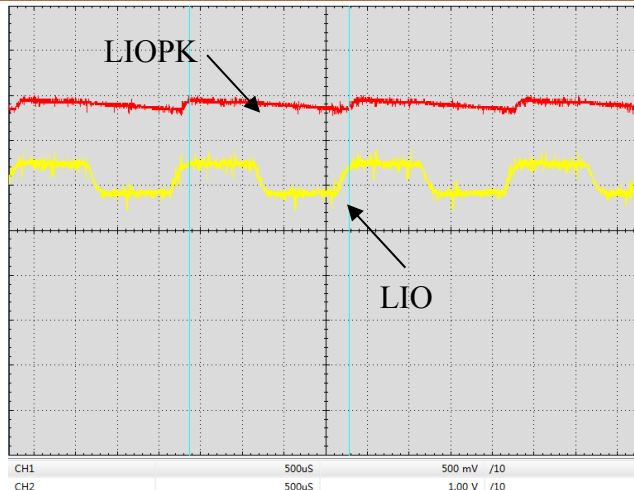

Figure 12. Digital Modulation Response at LIOPK & LIO Pin (f= 500Hz)

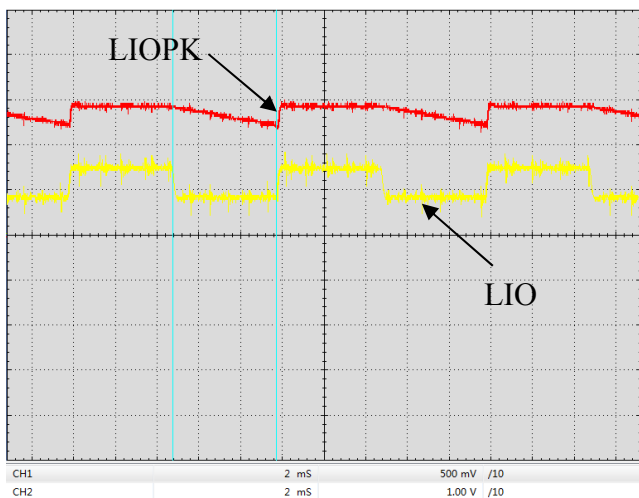

Figure 10. Digital Modulation Response at LIOPK & LIO Pin (f= 100Hz)

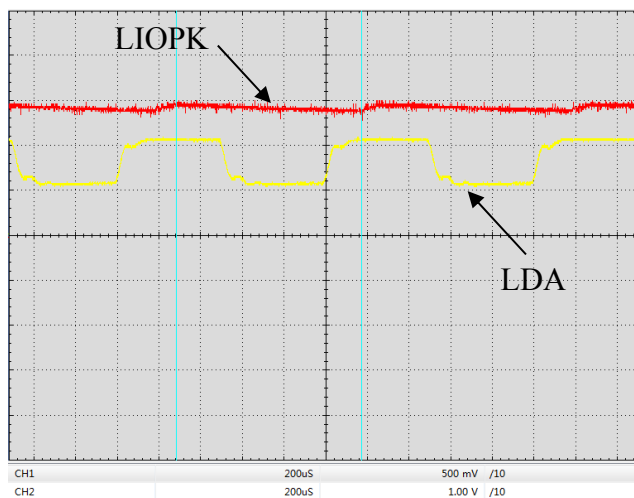

Figure 13. Digital Modulation Response at LIOPK & LDA Pin (f= 1kHz)

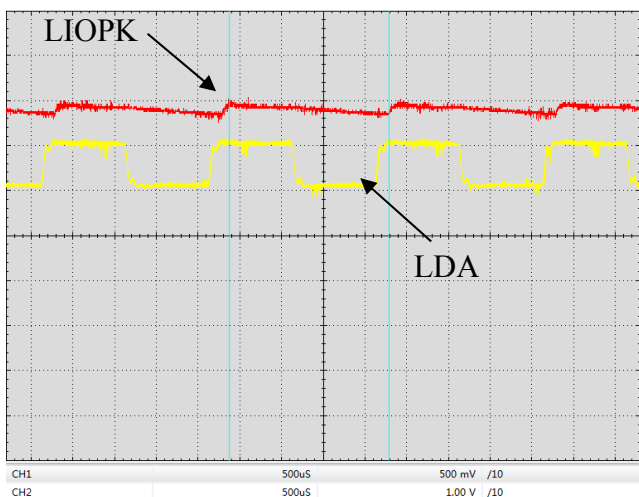

Figure 11. Digital Modulation Response at LIOPK & LDA Pin (f= 500Hz)

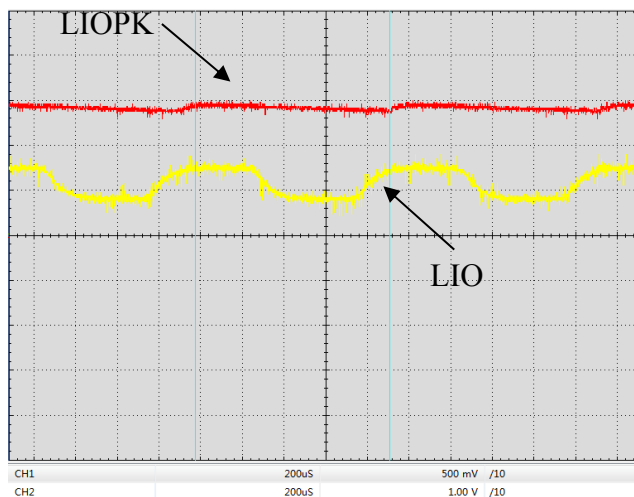

Figure 14. Digital Modulation Response at LIOPK & LIO Pin (f= 1kHz)

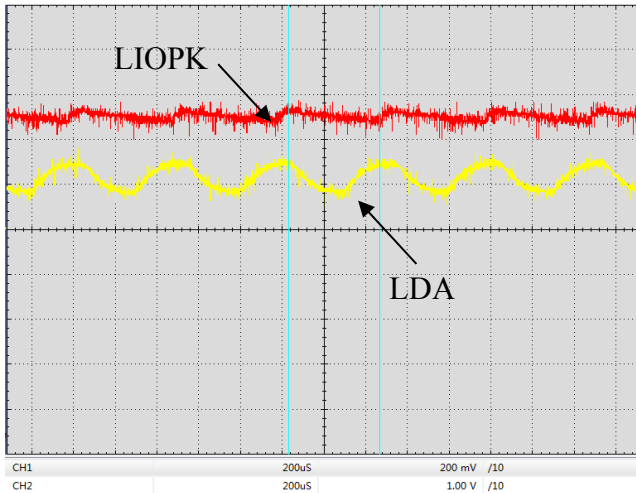

Figure 15. Digital Modulation Response at LIOPK & LDA Pin (f=2kHz)

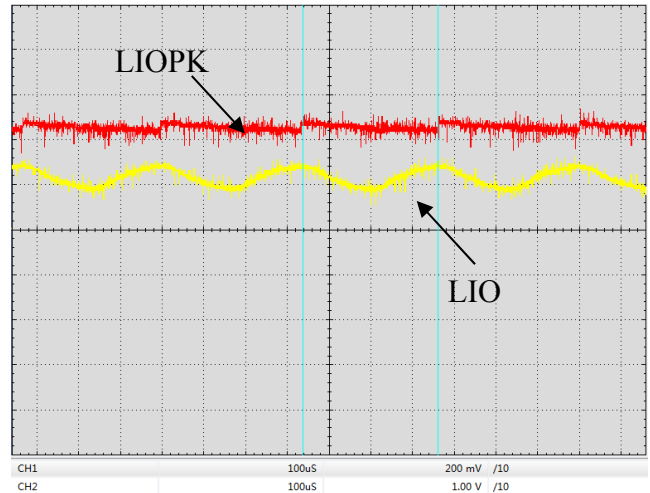

Figure 18. Digital Modulation Response at LIOPK & LIO Pin (f=3kHz)

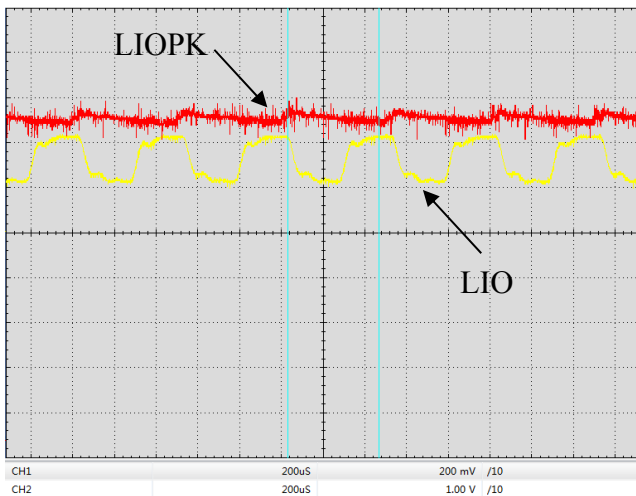

Figure 16. Digital Modulation Response at LIOPK & LIO Pin (f=2kHz)

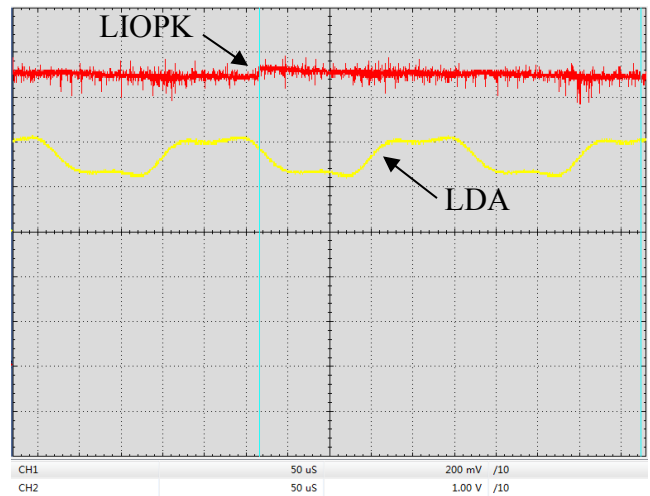

Figure 19. Digital Modulation Response at LIOPK & LDA Pin (f=4kHz)

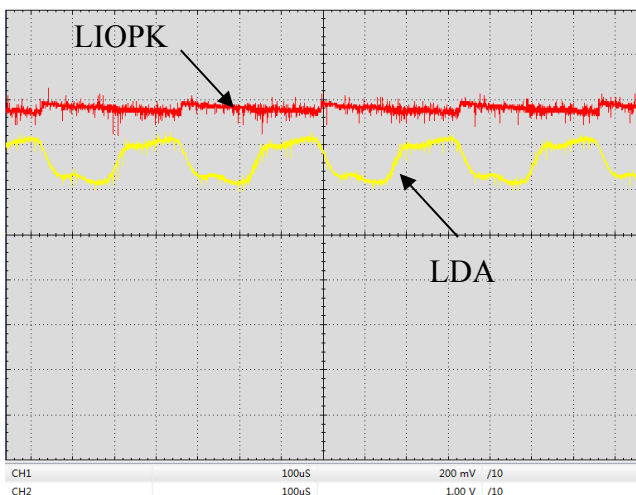

Figure 17. Digital Modulation Response at LIOPK & LDA Pin (f=3kHz)

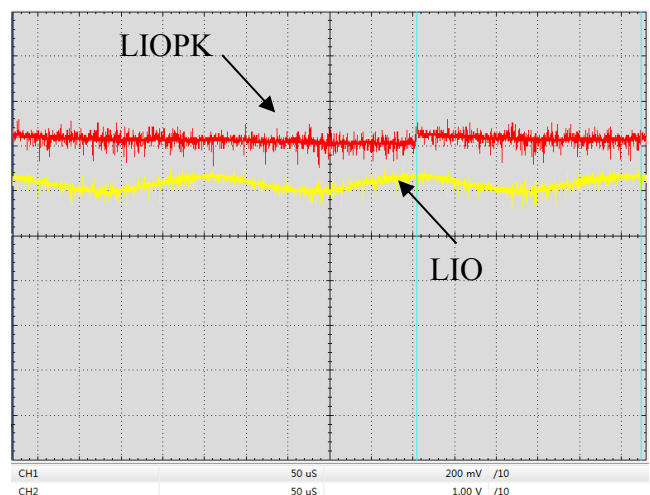

Figure 20. Digital Modulation Response at LIOPK & LIO Pin (f=4kHz)

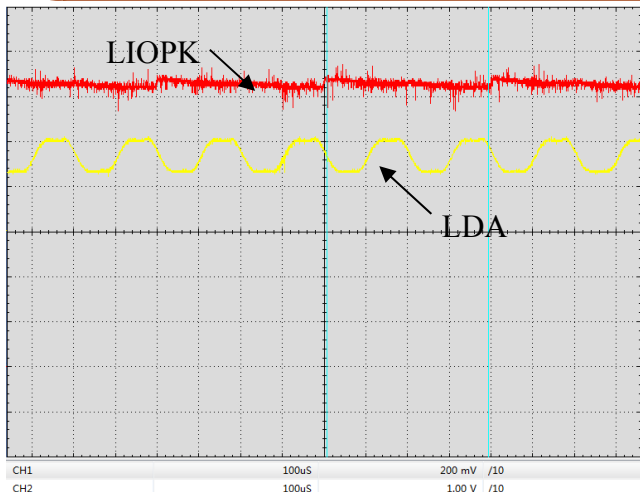

Figure 21. Digital Modulation Response at LIOPK & LDA Pin (f=5kHz)

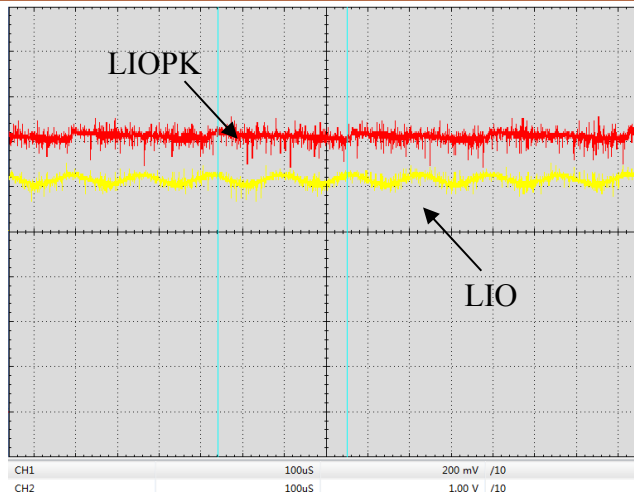

Figure 24. Digital Modulation Response at LIOPK & LIO Pin (f=6kHz)

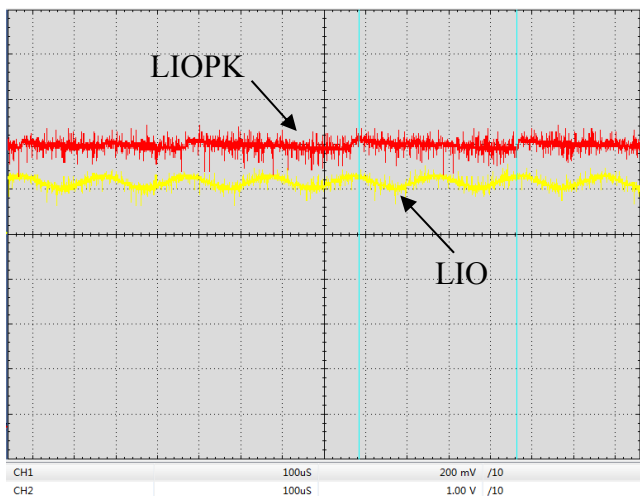

Figure 22. Digital Modulation Response at LIOPK & LIO Pin (f=5kHz)

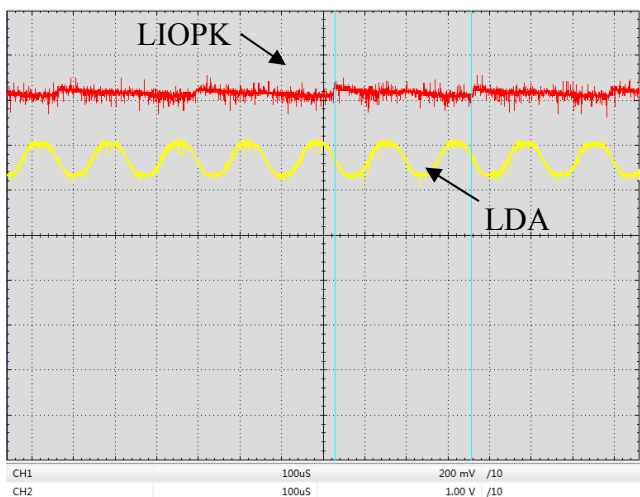

Figure 23. Digital Modulation Response at LIOPK & LDA Pin (f=6kHz)

C. Internal Temperature

The module's temperature equation is:

$$Temperature(^{\circ}C) = \frac{2.5418 - V_{TEMPO}}{0.01082} - 40$$

The V_{TEMPO} is the voltage of TEMPO pin. When the V_{TEMPO} varies from 2.5418V to 0.5692V, the temperature indicated is from -40 °C to 140°C.

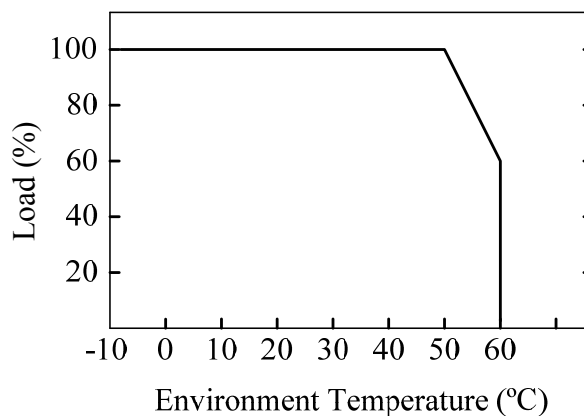

Figure 25. Derating Curve

The enable control pin, EN, is used for enabling the power supply. The logic threshold voltage is about 1.2V. When this pin is pulled down to <0.5V, the laser driver is disabled. There is a 100kΩ pull-up resistor tied to a 5V power supply internally. Leaving this pin unconnected or driving it to above the 1.2V threshold voltage will enable the laser driver.

The LPGD pin indicates the laser drivers works properly under constant current mode when this pin is pulled high. It can be used for driving an LED directly and the maximum output current is 5mA.



D. Testing Results

a. Start-up Waveform

Figure 26 shows the start-up waveform at the LDA pin. The voltage changes from 0V to 3V without over-shoot and the scanning speed is 50ms/D.

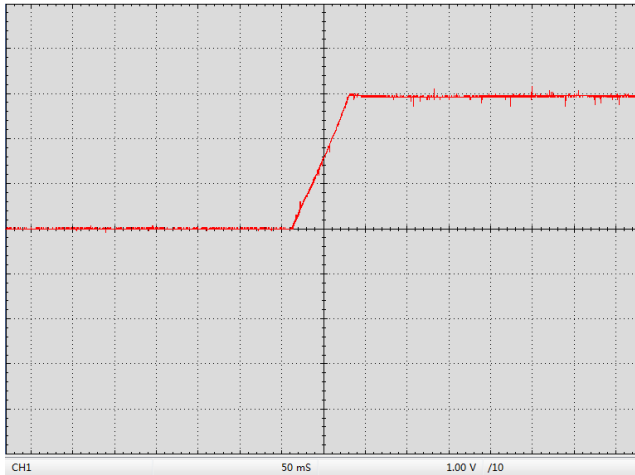

Figure 26. Start-up Waveform at LDA Pin

b. Ripple voltage

Ripple voltage on the LDA pin is 6mV when the output current is 15A, see Figure 27.

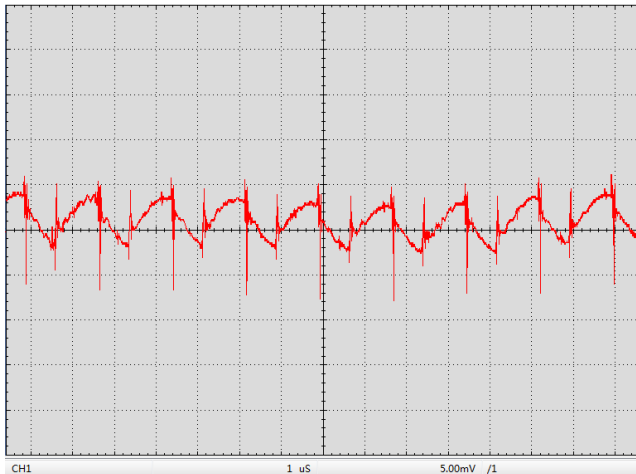

Figure 27. Noise Waveform at LDA Pin

E. Cautions

- Make sure the ground wire of the AC power plug is connected to the ground.
- Use anti-static measures, such as wrist straps, when handling the module so as not to damage the internal circuits.
- Always connect the module's AC input with a proper cable and a plug, do not use stripped wires as the plug for connecting to the AC main socket. Make sure that the cable wires are firmly tighten by screws onto the terminals to have reliable connections.
- When making modifications on the connections, always turn off the power first.
- Make sure that the polarity of the laser diode matches the polarity of the power supply's output.
- Carefully and patiently check the application circuit. After making sure that all the connections are correct, turn on the power supply. When the Loop Good LED light is lit up, it indicates that control loop is stable and working properly.
- To be on the safe side, we recommend using a dummy laser diode to replace the real laser diode first. The dummy diode can be consisted of a serial of 2 to 3 regular high current diodes, such as 50A to 80A, make sure that enough heat sinking is provided to the diodes, or simply immerse the diodes into a cup of water. Use oscilloscope to look at the output waveform at LDA pin for checking the soft-start and soft-cut circuit. The output current can be measured by measuring the LIO voltage, or to measure the output current directly, use a low resistance current sense resistor inserted into the dummy laser circuit and measure the voltage across the current sense resistor.



MECHANICAL DIMENSIONS

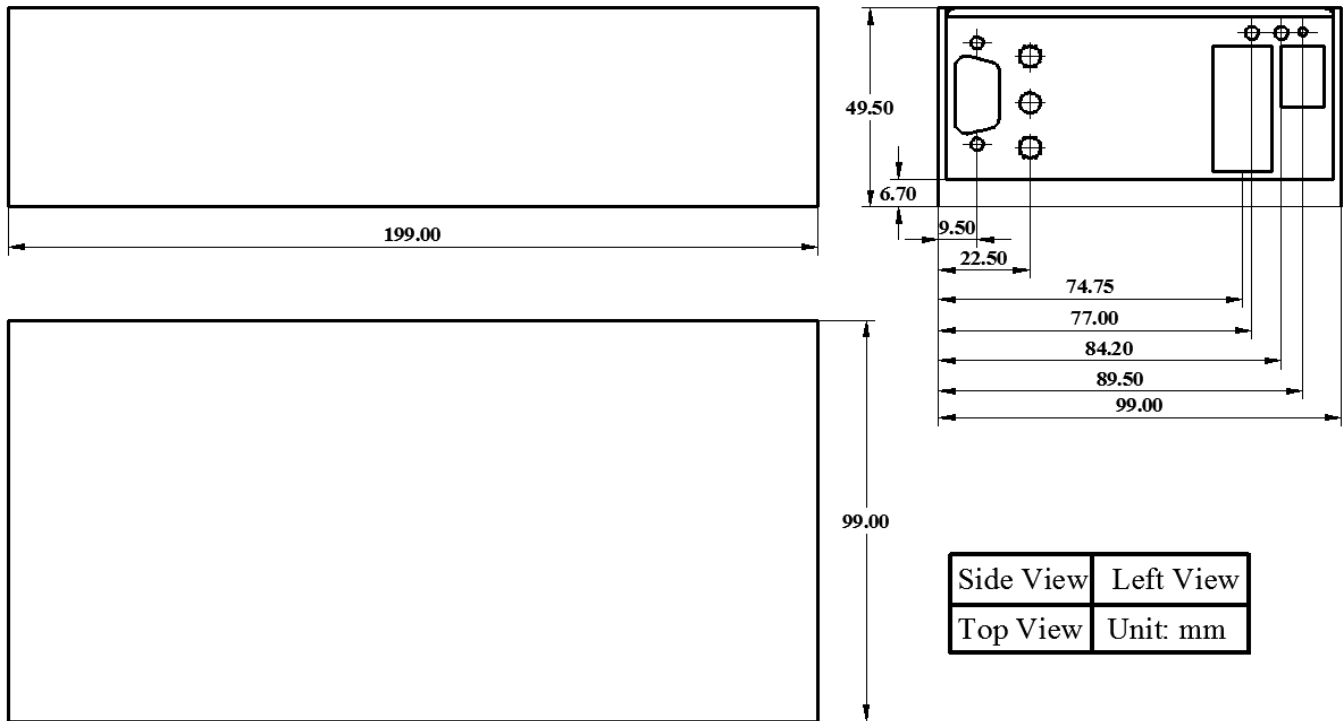

Figure 28. Mechanical Dimensions

NAMING

A AS 50A 6V 3

- Version: the 3rd version
- Maximum output voltage: 6V
- Maximum output current: 50A
- Circuit type: AC input/output isolated
- Company code: Analog Technologies, Inc.

ORDERING INFORMATION

TABLE 4. UNIT PRICE

Quantity (pcs)	1 – 9	10 – 49	50 – 249	250 – 499	≥500
AAS50A6V3	\$329	\$309	\$289	\$269	\$249



NOTICE

1. ATI warrants performance of its products for one year to the specifications applicable at the time of sale, except for those being damaged by excessive abuse. Products found not meeting the specifications within one year from the date of sale can be exchanged free of charge.
2. ATI reserves the right to make changes to its products or to discontinue any product or service without notice, and advise customers to obtain the latest version of relevant information to verify, before placing orders, that information being relied on is current and complete.
3. All products are sold subject to the terms and conditions of sale supplied at the time of order acknowledgment, including those pertaining to warranty, patent infringement, and limitation of liability. Testing and other quality control techniques are utilized to the extent ATI deems necessary to support this warranty. Specific testing of all parameters of each device is not necessarily performed, except those mandated by government requirements.
4. Customers are responsible for their applications using ATI components. In order to minimize risks associated with the customers' applications, adequate design and operating safeguards must be provided by the customers to minimize inherent or procedural hazards. ATI assumes no liability for applications assistance or customer product design.
5. ATI does not warrant or represent that any license, either express or implied, is granted under any patent right, copyright, mask work right, or other intellectual property right of ATI covering or relating to any combination, machine, or process in which such products or services might be or are used. ATI's publication of information regarding any third party's products or services does not constitute ATI's approval, warranty or endorsement thereof.
6. IP (Intellectual Property) Ownership: ATI retains the ownership of full rights for special technologies and/or techniques embedded in its products, the designs for mechanics, optics, plus all modifications, improvements, and inventions made by ATI for its products and/or projects.