



High Efficiency AC Input 40A 3.5V Laser Driver



Figure 1. Front View of the AAS40A3.5V2



Figure 3. Three-D View of the AAS40A3.5V2



Figure 2. Top View of the AAS40A3.5V2

FEATURES

- High efficiency:  $\geq 76\%$
- Maximum output current: 40A
- Wide output voltage: 0V ~ 3.5V
- Wide input voltage: 88VAC ~264VAC
- High speed digital modulation: 5 KHz
- Configurable output current and voltage limit
- Configurable digital modulation valley current
- Low temperature rise: 35°C
- Over-temperature protection
- Operating temperature: -20°C ~ 50°C
- Compact size
- Low cost
- 100 % lead (Pb)-free and RoHS compliant

APPLICATIONS

Driving diode lasers with high current and high stability, such as fiber lasers, diode laser bars, etc.

DESCRIPTIONS

The AAS40A3.5V2 is an electronic power supply block designed for driving diode lasers with up to 40A low noise current. The output current can be set by an analog voltage of 0 to 2.5V, an external potentiometer, or an internal potentiometer, to between 0 and 40A.

A pulsed output current can be generated by controlling the PCN port with a digital signal, under which, the peak output current is set by the LIS port while the valley output current is set by the LISL port. The modulation frequency can go up to 5 KHz, resulting to an approximately 56µS rise/fall time at the output current.

The AAS40A3.5V2 laser driver comes with a high stability low noise 2.5V reference voltage. It can be used for setting the output current and maximum output voltage. This reference can also be used as the voltage reference for external ADCs (Analog to Digital Converters) and DACS (Digital to Analog Converters), which might be used for monitoring and/or setting the laser current and maximum output voltage, the so-called compliance voltage.

This laser driver block is highly efficient; its efficiency is > 76%. It saves energy and has low temperature rise.

There is an over-temperature protection circuit inside, in case the laser power supply temperature exceeds the temperature limit, 85°C, the laser driver will shut down itself and be turned back on by itself after the temperature returns to the normal temperature range.

There is a soft-start circuit in this laser driver, which ensures smooth current transactions during power-up periods.

In case there is a short circuit at the output, the internal protection circuit will cut off the output.

The output voltage is automatically set from 0V to 3.5V to keep the output current at a pre-set value. The maximum voltage can be set by a potentiometer to between 2.6V to 3.5V. When the output voltage hits this set maximum value, the output voltage remains to be the maximum value and output current stop following the set value, the laser driver will be



working under constant voltage mode.

The control loop is monitored in real time by an internal circuit, to make sure that it works properly. The monitoring result is sent to the LPGD node. When this pin is pulled up internally, it indicates that the control loop works properly.

This pin signal can be sent to a microcontroller, or used for driving an LED through a buffer. The internal equivalent circuit of this pin is a 5KΩ pull-up resistor in parallel with an open drain comparator output.

The main specifications are shown in Table 1 below.

TABLE 1. SPECIFICATIONS (TA = 25°C)

Parameter	Symbol	Test Conditions	Min.	Typ.	Max.	Unit
Efficiency	$\eta$	$V_{in} = 110V\ AC, V_{out} = 3.5V, I_{out} = 40A$	-	76	-	%
Output Current	$I_{out}$	$V_{out} = 0V\ to\ 3.5V$	0	Adjustable	40	A
Current Accuracy	%	$-20^{\circ}C \sim 50^{\circ}C$	-	$\pm 1$	-	%
Input Voltage	$V_{in}$		88	110 or 220	264	VAC
Input Frequency	$F_{in}$		47	50	63	Hz
Output Voltage	$V_{out}$		2.6	Adaptive	3.5	V
Operating Temperature	$T_A$		-20	25	50	°C

CONNECTOR FUNCTIONS

The laser driver AAS40A3.5V2 has 2 connectors, Con 1 on the left side and Con 2 on the right side, as shown in Figure 1 and Figure 9. The Con 1 is a standard 15 pin female D-sub connector, the Con 2 is a 6 conductor terminal block, the former is for connecting control and monitor signals, the latter is for connecting to the laser diode. A typical connection schematic is shown in Figure 4 below.

APPLICATION INFORMATION

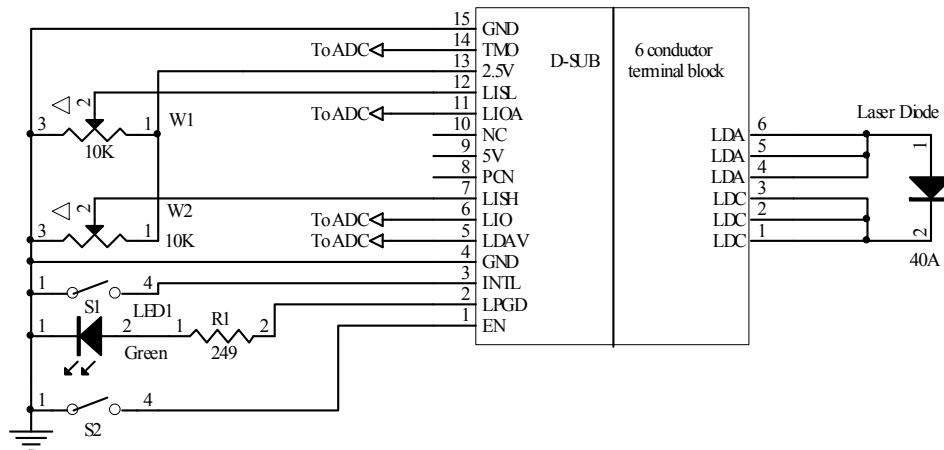

Figure 4. A Typical Application Schematic

The functions of all the pins in Con 1 are described in Table 2 below.

Table 2. Pin Function Description for Con 1 and Con 2 Connectors

Pin Number	Name	Meaning	Type	Description
Con 1 (D-Sub)	1	INTL	Interlock	Digital input Connect to a safety interlock switches. Open circuit=off, short to GND=run
	2&4&15	GND	Ground	Signal ground Connect ADC and DAC grounds here.
	3	LDAV	Laser diode anode output voltage	Digital input It equals to the voltage applied to the laser diode anode. The internal resistance is 50Ω.



	5	EN	Enable	Digital input	Internally pulled up to 5V by a 20K resistor. Pulling this pin to GND will disable the driver.
	6	LIO	Laser current output indication	Analog output	An output voltage of 0 to 2.5V at this pin indicates the output current being 0 to 40A linearly.
	7	LISH	Laser current set	Analog input	Setting this pin's voltage from 0V to 2.5V sets the output current from 0 to 40A linearly. This pin can be set by an external analog signal source, POT, or DAC. Input impedance is 10K. When modulating the laser by a digital signal through the PCN pin, this pin sets the output peak current.
	8	PCN	Pulse control	Digital input	TTL, 1 = sets the output current to be the value set by the LIS port or the internal LIS POT; 0 = sets the output current to be the valley current set by the LISL port or the internal POT.
	9	5V	Reference voltage	Analog output	A 5V reference voltage.
	10	NC			
	11	LIOA	Laser average output current indication	Analog output	This pin's voltage is always proportional to the average output current goes through the laser diode. The integration time constant for taking the average is about 0.1 second. An output voltage of 0 to 2.5V represents an average output current of 0 to 40A linearly.
	12	LISL	Laser valley current set	Analog input	When outputting pulse signal, a 0V to 2.5V voltage on this pin will set the output valley current to be 0A to 40A linearly. The internal POT can only set this pin's voltage between 0 to 0.67V, corresponding to an 8A current. When modulating the laser by a digital signal through the PCN pin, this pin sets the output valley current.
	13	2.5V	Reference voltage	Analog output	A 2.5V reference voltage. It can be used as a reference voltage for setting the output current and the output voltage limit by using external POTs or DACs. It can also be used by an ADC to measure the output analog voltages for monitoring the output parameters.
	14	LPGD	Loop good indication	Digital output	When this pin goes high (4V, ≤5mA), the control loop is working properly, otherwise, not properly.
<b>Con 2 (6 pin terminal block)</b>	4, 5 & 6	LDA	Laser diode anode	Power output	Connect it to the anode of the laser diode.
	1, 2 & 3	LDC	Laser diode cathode	Power output	Connect it to the cathode of the laser diode.

**B. Digital Modulation**

When needing digital modulation, i.e., on and off control, use PCN pin for controlling output current. When PCN is high, the output current, the peak current, is determined by LIS pin; when PCN is low, the output current, the valley current, is determined by LISL pin. The threshold voltage of PCN pin is about 2.5V. The maximum modulation frequency is 5 KHz.

The LISL pin sets the valley current to be between 0 to 8A by setting LISL pin voltage to between 0 to 2.5V linearly; LIS pin sets the output current to be between 0 to 40A when

setting this pin's voltage to between 0 to 2.5V linearly.

The output current formula is:

Highly current  $I_{out} = 16 \times LISH (A)$

Lowly current  $I_{out} = 3.2 \times LISL (A)$

VREF pin can be used as a 2.5V power supply, the maximum output current is 20mA.

LIO pin or LIOA pin indicates the output current:

Output current =  $16 \times LIO (A) = 16 \times LIOA (A)$



LIO represents the instant laser current, while LIOA is the average current.

### C. Internal Temperature

The module's temperature equation is:

$$\text{Temperature } (^{\circ}\text{C}) = 72 \times \text{TMO (V)} - 40 (^{\circ}\text{C})$$

When the TMO voltage varies from 0 to 2.5V, the temperature indicated is  $-40^{\circ}\text{C}$  to  $140^{\circ}\text{C}$ .

The enable control pin, EN, is used for enabling the power supply. The logic threshold voltage is about 2V. When this pin is pulled down, the laser driver is disabled. There is a 12K pull-up resistor tied to a 5V power supply internally. Leaving this pin unconnected or driving it to above the 2V threshold voltage will enable the laser driver.

The LPGD pin indicates the laser drivers works properly under constant current mode when this pin is pulled high. It can be used for driving an LED directly and the maximum output current is 5mA.

### D. Testing Results

#### a. Digital Modulation Response Waveforms

When the input PCN is a 500Hz digital signals, the response waveform measured at LDA pin is shown in Figure 5 and the rise and fall time is approximately  $56\mu\text{S}$ . The waveform changes from 0.4V to 2V and scanning speed is  $50\mu\text{s/D}$ . Figure 6 shows the same waveform with slower scanning speed:  $500\mu\text{s/D}$ .

When the input PCN is a 5KHz digital signal, measured output at LDA pin is shown in Figure 7, the voltage changes from 0.2V to 2.4V and scanning speed is  $50\mu\text{s/D}$ .

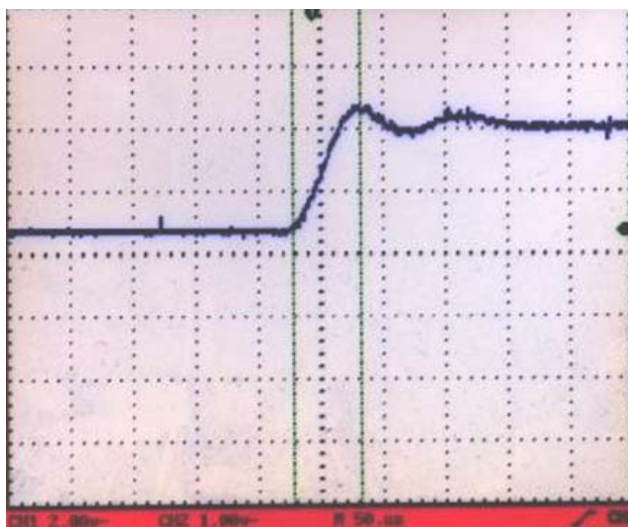

Figure 5 . Digital Modulation Response at LDA Pin

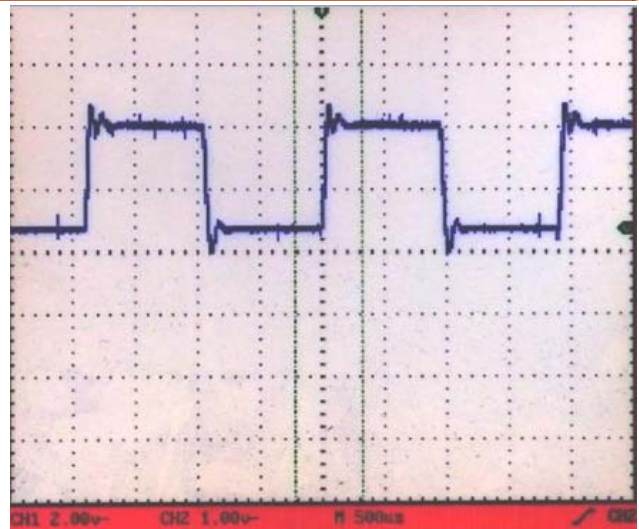

Figure 6. Digital Modulation Response at LDA Pin

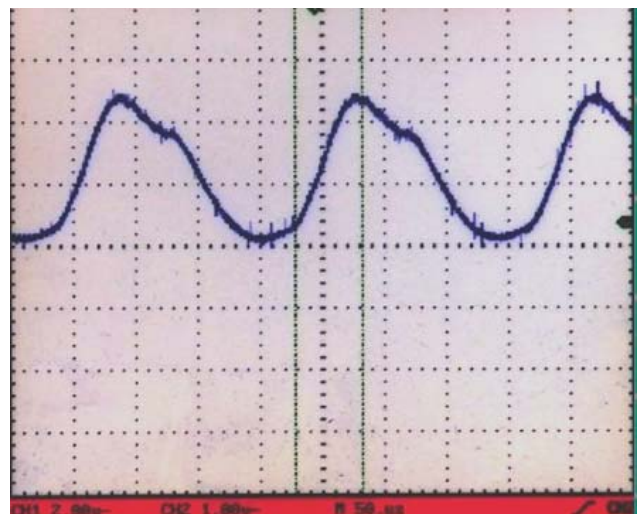

Figure 7. Digital Modulation Response at LDA Pin

#### b. Start-up Waveform

Figure 8 shows the start-up waveform at the LDA pin, the voltage changes from 0V to 1.3V without over-shoot and the scanning speed is  $50\text{ns/D}$ .

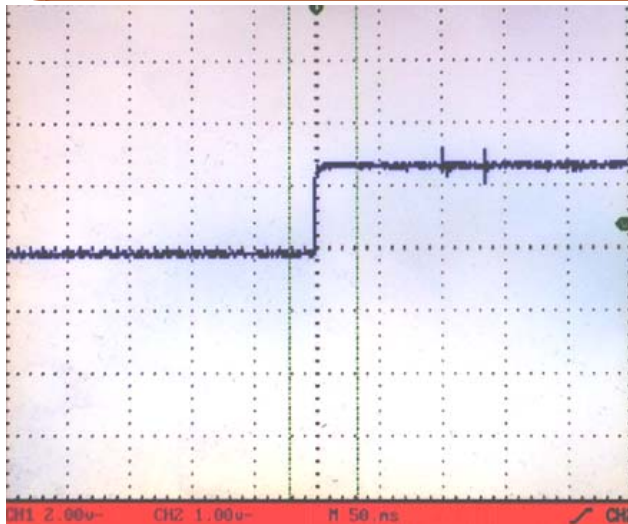

Figure 8. Start-up Waveform at LDA Pin

**E. Cautions**

- a. Use anti-static measures, such as wrist straps, when handling the module so as not to damage the internal circuits.
- b. Always connect the module's AC input with a proper cable and a plug, do not use stripped wires as the plug for connecting to the AC main socket. Make sure that

the cable wires are firmly tighten by screws onto the terminals to have reliable connections.

- c. When making modifications on the connections, always turn off the power first.
- d. Make sure that the polarity of the laser diode matches the polarity of the power supply's output.
- e. Carefully and patiently check the application circuit. After making sure that all the connections are correct, turn on the power supply. When the LPGD LED light is lit up, it indicates that control loop is stable and working properly.
- f. To be on the safe side, we recommend using a dummy laser diode to replace the real laser diode first. The dummy diode can be consisted of a serial of 2 to 3 regular high current diodes, such as 40A to 80A, make sure that enough heat sinking is provided to the diodes, or simply immerse the diodes into a cup of water. Use oscilloscope to look at the output waveform at LDA pin for checking the soft-start and soft-cut circuit. The output current can be measured by measuring the LIO voltage, or to measure the output current directly, use a low resistance current sense resistor inserted into the dummy laser circuit and measure the voltage across the current sense resistor.



MECHANICAL DIMENSIONS

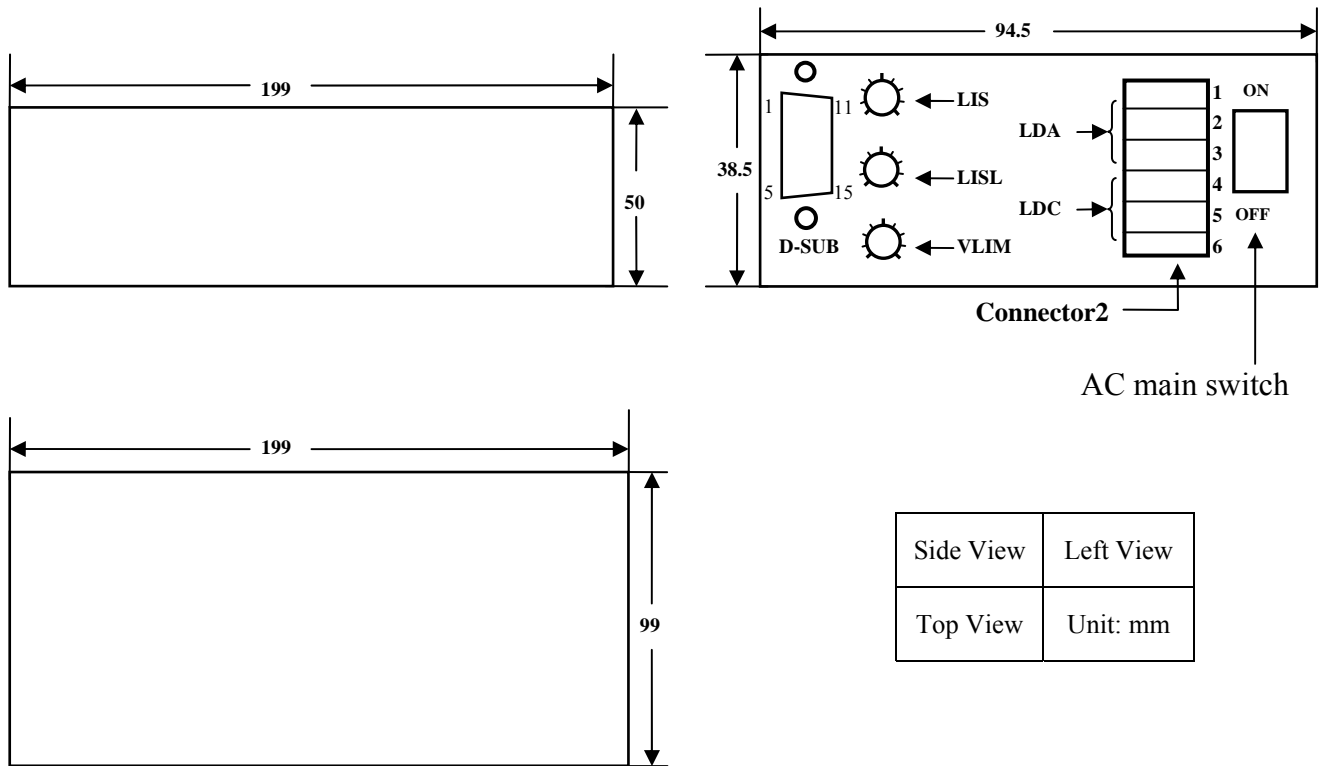
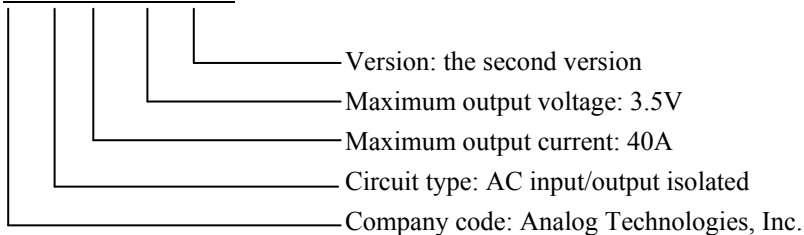

Figure 9. Pin Names and Locations

NAMING

AAS40A3.5V2



ORDERING INFORMATION

Table 4 Unit Price

Quantity	1 – 9	10 – 49	50 – 249	250 – 499	500 – 999	≥1000
AAS40A3.5V2	\$320	\$290	\$250	\$220	\$190	\$180

NOTICE

- ATI warrants performance of its products for one year to the specifications applicable at the time of sale, except for those being damaged by excessive abuse. Products found not meeting the specifications within one year from the date of sale can be exchanged free of charge.
- ATI reserves the right to make changes to its products or to discontinue any product or service without notice, and advise customers to obtain the latest version of relevant information to verify, before placing orders, that information being relied on is current and complete.



3. All products are sold subject to the terms and conditions of sale supplied at the time of order acknowledgment, including those pertaining to warranty, patent infringement, and limitation of liability. Testing and other quality control techniques are utilized to the extent ATI deems necessary to support this warranty. Specific testing of all parameters of each device is not necessarily performed, except those mandated by government requirements.
4. Customers are responsible for their applications using ATI components. In order to minimize risks associated with the customers' applications, adequate design and operating safeguards must be provided by the customers to minimize inherent or procedural hazards. ATI assumes no liability for applications assistance or customer product design.
5. ATI does not warrant or represent that any license, either express or implied, is granted under any patent right, copyright, mask work right, or other intellectual property right of ATI covering or relating to any combination, machine, or process in which such products or services might be or are used. ATI's publication of information regarding any third party's products or services does not constitute ATI's approval, warranty or endorsement there of.
6. IP (Intellectual Property) Ownership: ATI retains the ownership of full rights for special technologies and/or techniques embedded in its products, the designs for mechanics, optics, plus all modifications, improvements, and inventions made by ATI for its products and/or projects.