



High Efficiency AC Input 100A 5V Laser Driver

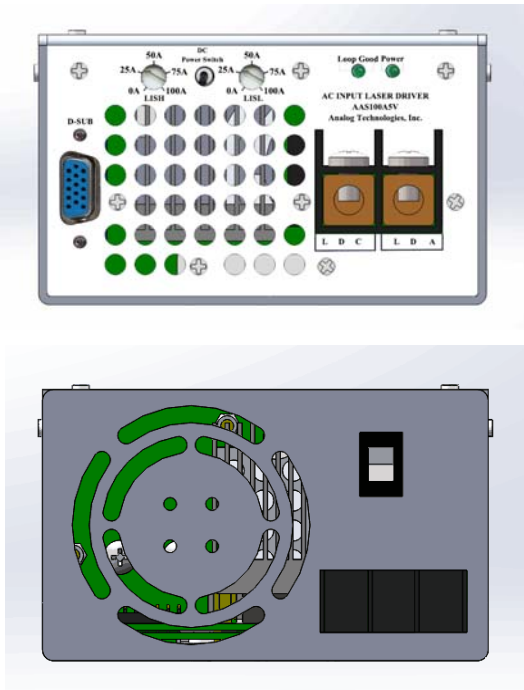

Figure 1. Top View of the AAS100A5V1

FEATURES

- High efficiency: $\geq 85\%$
- Maximum output current: 100A
- Wide output voltage: 0V ~ 5V
- Wide input voltage: 100VAC ~ 240VAC
- High speed digital modulation: 2kHz
- Configurable output current and voltage limit
- Configurable digital modulation valley current
- Low temperature rise: 30°C
- Over-temperature protection
- Operating temperature: -20°C ~ 50°C
- MBTF (Mean Time Before Failure): 180,000 hours
- The ripple noise at 600kHz: $<24mV_{p-p}$
- Compact size
- Low cost
- 100 % lead (Pb)-free and RoHS compliant

APPLICATIONS

Driving diode lasers with high current and high stability, such as fiber lasers, diode laser bars, etc.

DESCRIPTIONS

The AAS100A5V1 is an electronic power supply block designed for driving diode lasers with up to 100A low noise current. The output current can be set by an analog voltage of 0V to 5V, an external potentiometer, or an internal potentiometer, to between 0A and 100A.

A pulsed output current can be generated by controlling the PCN port with a digital signal, under which, the peak output current is set by the LISL port while the valley output current is set by the LISR port. The modulation frequency can go up to 2kHz, resulting to an approximately 200µS rise/fall time at the output current.

The AAS100A5V1 laser driver comes with a high stability low noise 4V reference voltage. It can be used for setting the output current and maximum output voltage. This reference can also be used as the voltage reference for external ADCs (Analog to Digital Converters) and DACs (Digital to Analog Converters), which might be used for monitoring and/or setting the laser current and maximum output voltage, the so-called compliance voltage.

This laser driver block is highly efficient: its efficiency is $\geq 85\%$. It saves energy and has low temperature rise. " " "

There is an over-temperature protection circuit inside, in case the laser power supply temperature exceeds the temperature limit, 85°C, the laser driver will shut down itself and be turned back on by itself after the temperature returns to the normal temperature range.

There is a soft-start circuit in this laser driver, which ensures smooth current transactions during power-up periods.

In case there is a short circuit at the output, the internal protection circuit will cut off the output.

The output voltage is automatically set from 0V to 5V to keep the output current at a pre-set value. The maximum voltage can be set by a potentiometer to between 0V and 5V. When the output voltage hits this set maximum value, the output voltage remains to be the maximum value and output current stop following the set value, the laser driver will be working under constant voltage mode.

The control loop is monitored in real time by an internal circuit, to make sure that it works properly. The monitoring result is sent to the LPGD node. When this pin is pulled up internally, it indicates that the control loop works properly and Loop Good LED will be lit. This pin signal can be sent to a microcontroller, or used for driving an LED through a buffer. The internal equivalent circuit of this pin is a 5kΩ pull-up resistor in parallel with an open drain comparator output.

The main specifications are shown in Table 1 below.



Table 1. Specifications ($T_A = 25^\circ\text{C}$)

Parameter	Symbol	Test Conditions	Min.	Typ.	Max.	Unit
Efficiency	η	$V_{IN} = 110\text{V AC}$, $V_{OUT} = 4\text{V}$, $I_{OUT} = 100\text{A}$	-	85	-	%
Output Current	I_{OUT}	$V_{OUT} = 0\text{V to } 4\text{V}$	0	Adjustable	100	A
Current Accuracy	%	$-20^\circ\text{C} \sim 50^\circ\text{C}$	-	± 0.5	-	%
Input Voltage	V_{IN}		88	110 or 220	264	VAC
Input Frequency	F_{IN}		47	50 or 60	63	Hz
Output Voltage	V_{OUT}		0	Adaptive	5	V
Ripple Noise	$V_{RIP}(600\text{KHz})$	$V_{IN} = 110\text{V AC}$, $V_{OUT} = 4\text{V}$, $I_{OUT} = 20\text{A}$	18	24	30	mV _{P-P}
Output Current Noise	$I_{ON}(0.1\text{-}10\text{Hz})$	$V_{IN}=110\text{VAC}$, $V_{OUT}=2.5\text{V}$, $I_{OUT}= 50\text{A}$, $R_S=0.05\Omega$, $f=0.1\text{Hz to } 10\text{Hz}$.	0.8	1	1.2	mA _{P-P}
Operating Temperature	T_A		-20	25	50	$^\circ\text{C}$

CONNECTOR FUNCTIONS

The laser driver AAS100A5V1 has 2 connectors, Con 1 on the left side and Con 2 on the right side, as shown in Figure 1 and Figure 27. The Con 1 is a standard 15-pin female D-SUB connector, the Con 2 is a 2-conductor terminal block, the former is for connecting the control and monitor signals, the latter is for connecting to the laser diode. A typical connection schematic is shown in Figure 2 below.

APPLICATION INFORMATION

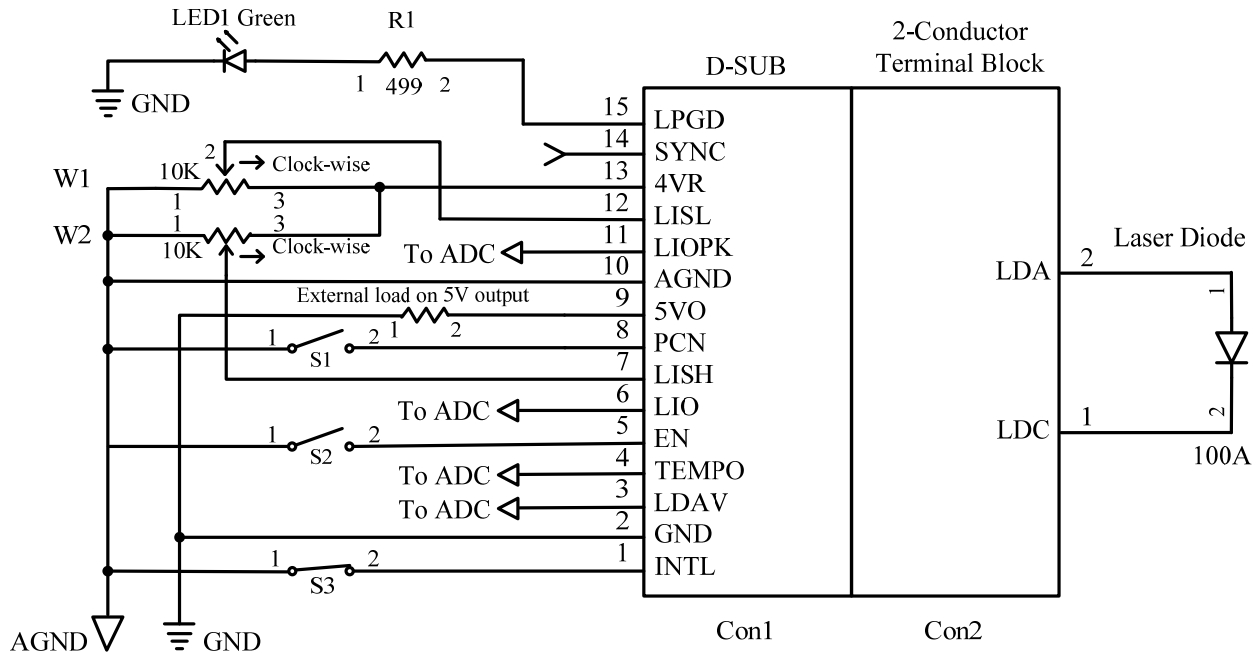

Figure 2. A Typical Application Schematic



The functions of all the pins in Con 1 are described in Table 2 below.

Table 2. Pin Function Description for Con 1 and Con 2 Connectors

Pin Number	Name	Meaning	Type	Description	
Con 1 (D-Sub)	1	INTL	Interlock	Digital input	Connect to a safety interlock switches. Open circuit = off, short to GND = run.
	2	GND	Ground	Analog ground	Connect power grounds here.
	3	LDAV	Laser diode anode output voltage indication	Analog output	It equals to half of the voltage applied to the laser diode anode. The internal resistance is 10kΩ.
	4	TEMPO	Temperature indication	Analog output	It's voltage proportional to the temperature of the driver. See section C for details.
	5	EN	Enable	Digital input	Internally pulled up to 5V by a 100k resistor. Pulling this pin to GND will disable the driver.
	6	LIO	Laser current output indication	Analog output	An output voltage of 0 to 4V at this pin indicates the output current being 0 to 100A linearly.
	7	LISH	Laser current set	Analog input	Setting this pin's voltage from 0V to 4V sets the output current from 0 to 100A linearly. This pin can be set by an external analog signal source, POT, or DAC. Input impedance is 125Ω. When modulating the laser by a digital signal through the PCN pin, this pin sets the output peak current.
	8	PCN	Pulse control	Digital input	TTL, 1 = sets the output current to be the value set by the LISH port or the internal LISH POT; 0 = sets the output current to be the valley current set by the LISL port or the internal LISL POT.
	9	5VO	Reference voltage	Analog output	A 5V reference voltage.
	10	AGND	Ground	Signal ground	Connect ADC and DAC grounds here.
	11	LIOPK	Laser peak output current indication	Analog output	This pin's voltage is always proportional to the peak output current going through the laser diode. An output voltage of 0 to 4V represents a peak output current of 0 to 100A linearly.
	12	LISL	Laser valley current set	Analog input	When outputting pulse signal, a 0V to 4V voltage on this pin will set the output valley current to be 0A to 100A linearly. The internal POT can set this pin's voltage between 0 to 4V, corresponding to a 100A current. When modulating the laser by a digital signal through the PCN pin, this pin sets the output valley current.
	13	4VR	Reference voltage	Analog output	A 4V reference voltage. It can be used as a reference voltage for setting the output current and the output voltage limit by using external POTs or DACs. It can also be used by an ADC to measure the output analog voltages for monitoring the output parameters.
	14	LPGD	Loop good indication	Digital output	When this pin goes high (5V, ≤5mA), the control loop is working properly, otherwise, not properly.



	15	SYNC	Synchronization input	Digital input	The driver synchronizes on the falling edge of a square wave provided to this pin. The peak voltage of the square wave should be higher than 4V but lower than 7V. And the valley voltage of the square wave should be less than 1V. The frequency of the square wave should be between 500k and 600kHz.
Con 2 (2 pin terminal block)	1	LDC	Laser diode cathode	Power output	Connect it to the cathode of the laser diode.
	2	LDA	Laser diode anode	Power output	Connect it to the anode of the laser diode.

Table 3. Copper Wire Specification

Specification	Wire Diameter	Carrying Capacity
1.0mm ²	1.13mm	14A 17A
1.5mm ²	1.39mm	21A 23A
2.5mm ²	1.79mm	28A 32A
4.0mm ²	2.25mm	37A 48A
6.0mm ²	2.76mm	48A 60A
10.0mm ²	3.57mm	65A 90A
16.0mm ²	4.52mm	91A 100A

A. Analog Modulation

When needing the driver to output constant current, we should set PCN pin for modulation. We can set PCN high or unconnected, and the output current will be between 0A and 45A linearly by setting LISH pin from 0V to 5V.

We can also set PCN low, and the output current will be between 0A and 100A linearly by setting LISL pin from 0V to 5V.

The Input Control Switch is the modulation type selector switch. When needing analog modulation, dial the switch to the lower side. And dial the switch to the upper side for digital modulation.

B. Digital Modulation

When needing digital modulation, i.e., on and off control, use PCN pin for controlling output current. When PCN is high, the output current, the peak current, is determined by LISH pin; when PCN is low, the output current, the valley current, is determined by LISL pin. The threshold voltage of PCN pin is about 4V, but don't exceed 5V. The maximum modulation frequency is 2kHz. See Figure 3.

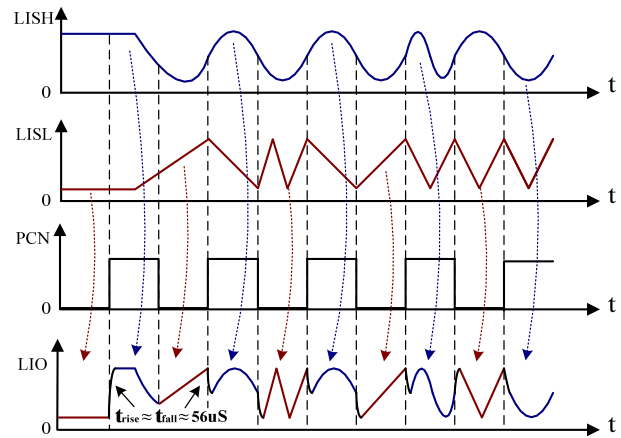

Figure 3. Digitally Controlled Analog Modulation Principle

The LISL pin sets the valley current to be between 0A and 45A by setting LISL pin voltage to between 0V to 4V linearly; LISH pin sets the output current to be between 0A to 45A when setting this pin's voltage to between 0V to 4V linearly.

The output current formula is:

Highly current $I_{OUT} = 25 \times V_{LISH}$ (A)

Lowly current $I_{OUT} = 25 \times V_{LISL}$ (A)

4VR pin can be used as a 4V power supply, the maximum output current is 20mA.

LIO pin or LIOPK pin indicates the output current:

Output current = $25 \times V_{LIO}$ (A)

LIO represents the instant laser current, while LIOPK is the peak current. When the modulation speed exceeds 2kHz, LIOPK will not have the function of indication.

Figure 4 is the mathematic model of the LIOPK's waveform. It's an exponential function, and see the practical waveform in Figure 8.

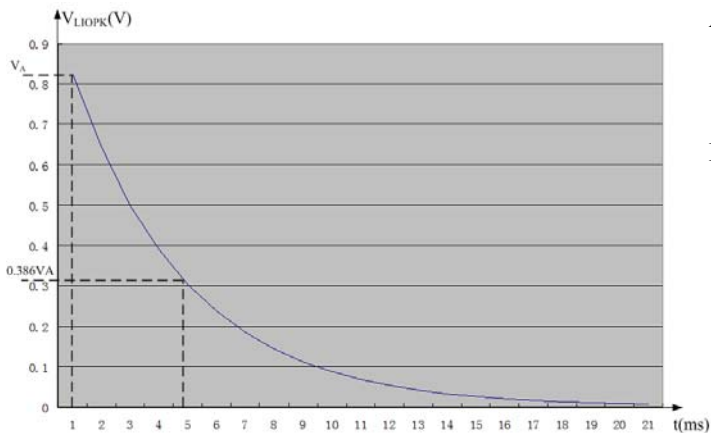

Figure 4. LIOPK's Mathematic Model

Attenuation speed formula of LIOPK's waveform is:

$$V_{LIOPK}(t) = V_A e^{-\frac{t}{100ms}}$$

$$\text{Peak output current} = 18 \times V_{LIOPK}(A)$$

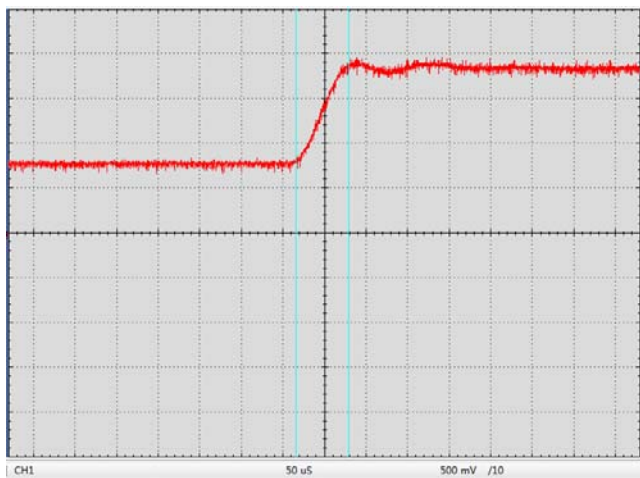

Figure 5. Digital Modulation Response at LDA Pin

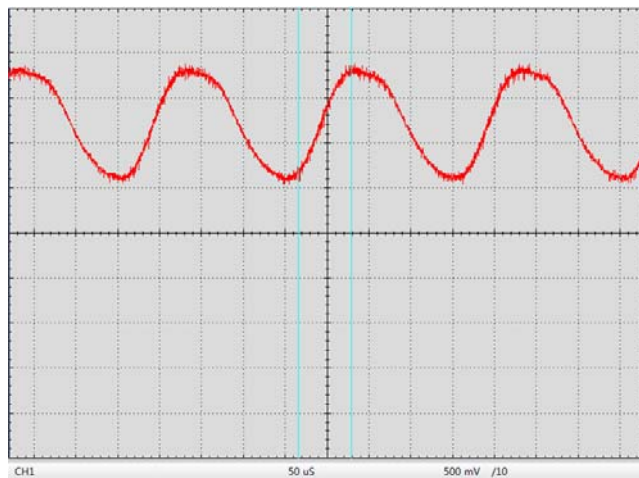

Figure 7. Digital Modulation Response at LDA Pin

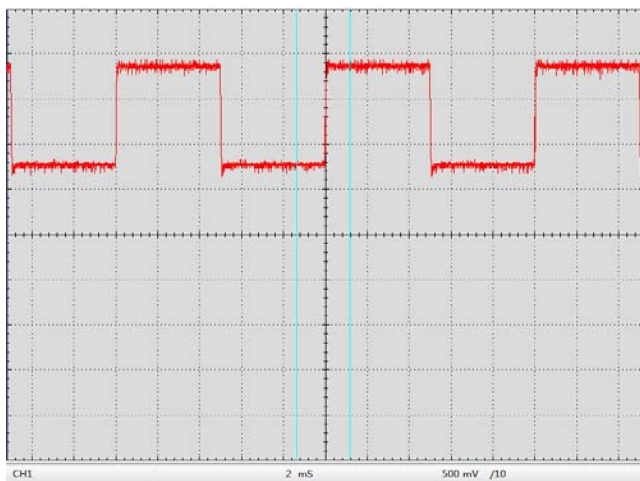

Figure 6. Digital Modulation Response at LDA Pin

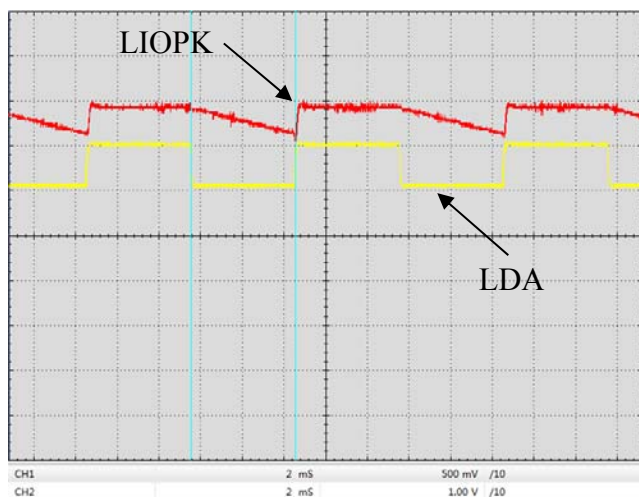

Figure 8. Digital Modulation Response at LIOPK & LDA Pin ($f = 100\text{Hz}$)

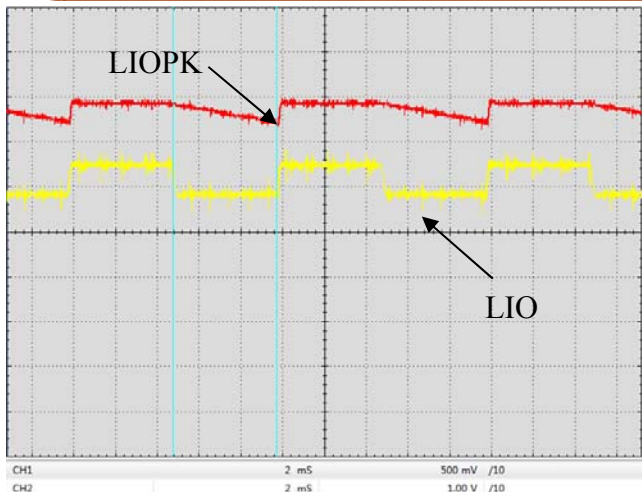

Figure 9. Digital Modulation Response at LIOPK & LIO Pin (f = 100Hz)

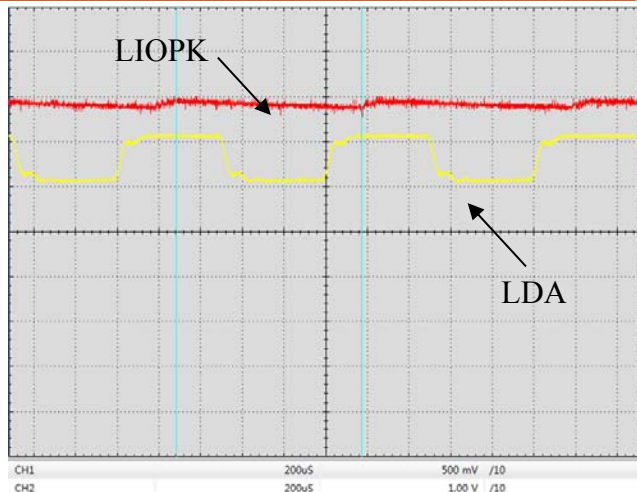

Figure 12. Digital Modulation Response at LIOPK & LDA Pin (f = 1kHz)

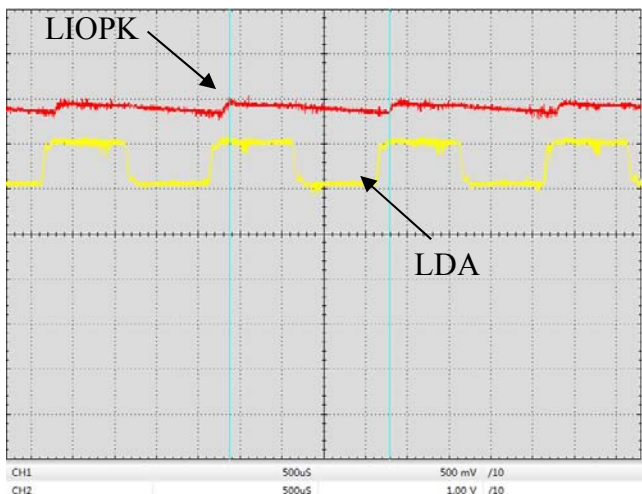

Figure 10. Digital Modulation Response at LIOPK & LDA Pin (f = 500Hz)

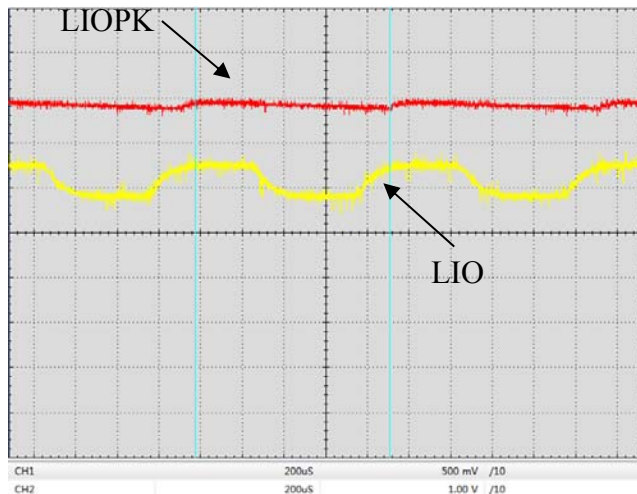

Figure 13. Digital Modulation Response at LIOPK & LIO Pin (f = 1kHz)

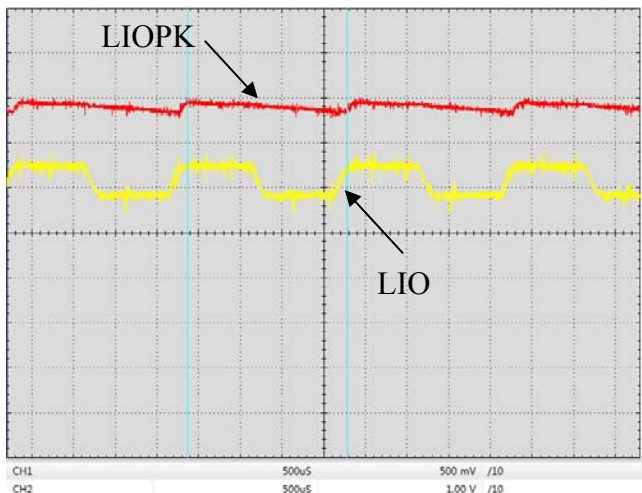

Figure 11. Digital Modulation Response at LIOPK & LIO Pin (f = 500Hz)

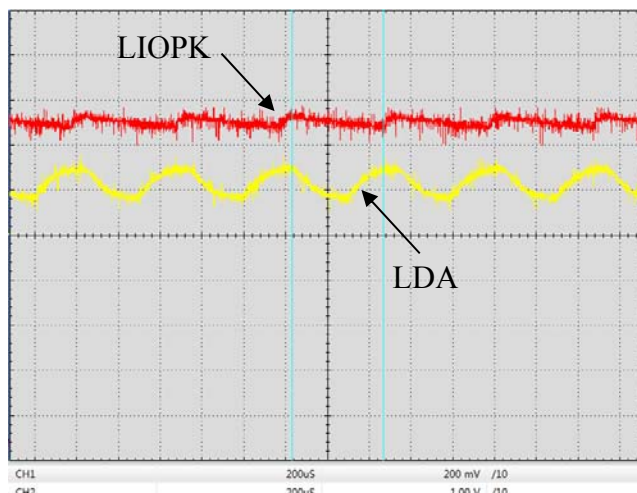

Figure 14. Digital Modulation Response at LIOPK & LDA Pin (f = 2kHz)

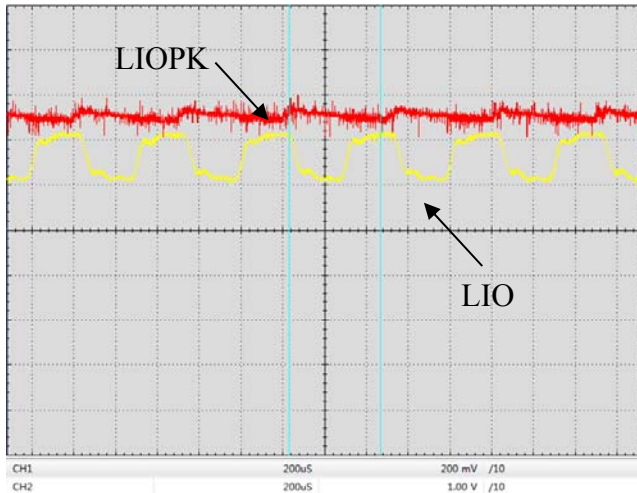

Figure 15. Digital Modulation Response at LIOPK & LIO Pin (f = 2kHz)

C. Internal Temperature

The module’s temperature equation is:

$$Temperature(^{\circ}C) = \frac{2.5418 - V_{TEMPO}}{0.01082} - 40$$

When the TEMPO voltage varies from 2.5418V to 0.5692V, the temperature indicated is from -40 °C to 140°C.

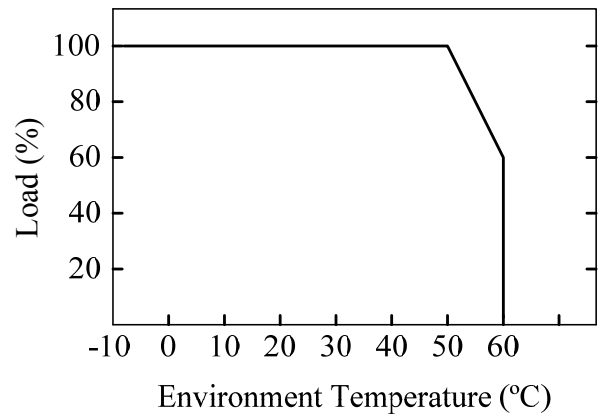

Figure 16. Derating Curve

The enable control pin, EN, is used for enabling the power supply. The logic threshold voltage is about 1.2V. When this pin is pulled down to <0.5V, the laser driver is disabled. There is a 100k pull-up resistor tied to a 5V power supply internally. Leaving this pin unconnected or driving it to above the 1.2V threshold voltage will enable the laser driver.

The LPGD pin indicates the laser drivers works properly under constant current mode when this pin is pulled high. It can be used for driving an LED directly and the maximum output current is 5mA.



D. Testing Results

a. Start-up Waveform

Figure 17 shows the start-up waveform at the LDA pin. The voltage changes from 0V to 3V without over-shoot and the scanning speed is 50ms/D.

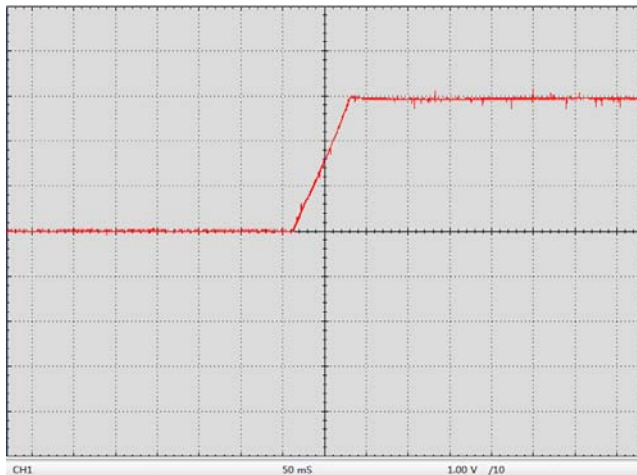

Figure 17. Start-up Waveform at LDA Pin

b. Ripple voltage

E. Cautions

- Make sure the ground wire of the AC power plug is connected to the ground.
- Use anti-static measures, such as wrist straps, when handling the module so as not to damage the internal circuits.
- Always connect the module's AC input with a proper cable and a plug, do not use stripped wires as the plug for connecting to the AC main socket. Make sure that the cable wires are firmly tightened by screws onto the terminals to have reliable connections.
- When making modifications on the connections, always turn off the power first.
- Make sure that the polarity of the laser diode matches the polarity of the power supply's output.
- Carefully and patiently check the application circuit. After making sure that all the connections are correct, turn on the power supply. When the Loop Good LED light is lit up, it indicates that control loop is stable and working properly.
- To be on the safe side, we recommend using a dummy laser diode to replace the real laser diode first. The dummy diode can be consisted of a serial of 2 to 3 regular high current diodes, such as 45A to 80A, make sure that enough heat sinking is provided to the diodes, or simply immerse the diodes into a cup of water. Use oscilloscope to look at the output waveform at LDA pin for checking the soft-start and soft-cut circuit. The output current can be measured by measuring the LIO voltage, or to measure the output current directly, use a low resistance current sense resistor inserted into the dummy laser circuit and measure the voltage across the current sense resistor.

Ripple voltage on the LDA pin is 6mV when the output current is 15A, see Figure 18.

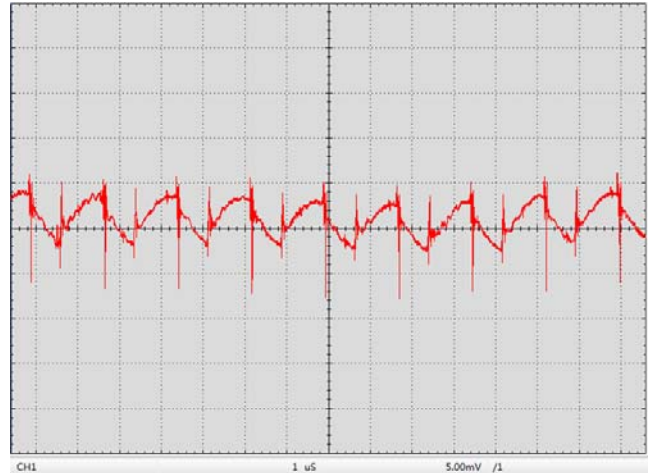

Figure 18. Noise Waveform at LDA Pin



MECHANICAL DIMENSIONS

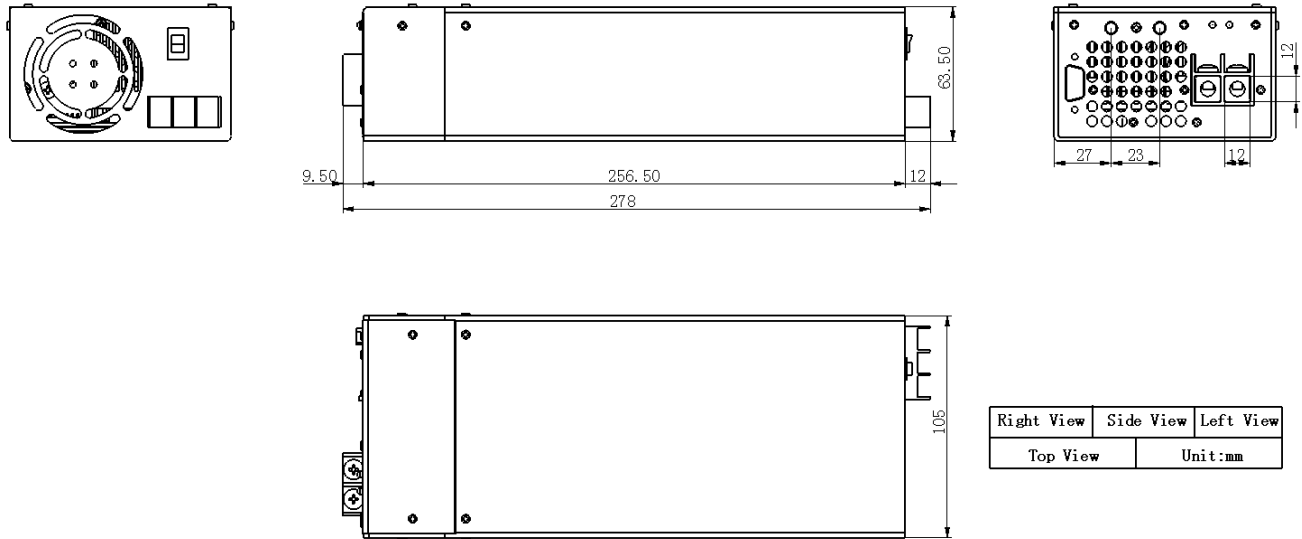

Figure 19. Mechanical Dimensions

NAMING RULES

A AS 100A 5V 1

- Version: the second version
- Maximum output voltage: 4V
- Maximum output current: 45A
- Circuit type: AC input/output isolated
- Company code: Analog Technologies, Inc.



NOTICE

1. ATI warrants performance of its products for one year to the specifications applicable at the time of sale, except for those being damaged by excessive abuse. Products found not meeting the specifications within one year from the date of sale can be exchanged free of charge.
2. ATI reserves the right to make changes to its products or to discontinue any product or service without notice, and advise customers to obtain the latest version of relevant information to verify, before placing orders, that information being relied on is current and complete.
3. All products are sold subject to the terms and conditions of sale supplied at the time of order acknowledgment, including those pertaining to warranty, patent infringement, and limitation of liability. Testing and other quality control techniques are utilized to the extent ATI deems necessary to support this warranty. Specific testing of all parameters of each device is not necessarily performed, except those mandated by government requirements.
4. Customers are responsible for their applications using ATI components. In order to minimize risks associated with the customers' applications, adequate design and operating safeguards must be provided by the customers to minimize inherent or procedural hazards. ATI assumes no liability for applications assistance or customer product design.
5. ATI does not warrant or represent that any license, either express or implied, is granted under any patent right, copyright, mask work right, or other intellectual property right of ATI covering or relating to any combination, machine, or process in which such products or services might be or are used. ATI's publication of information regarding any third party's products or services does not constitute ATI's approval, warranty or endorsement there of.
6. IP (Intellectual Property) Ownership: ATI retains the ownership of full rights for special technologies and/or techniques embedded in its products, the designs for mechanics, optics, plus all modifications, improvements, and inventions made by ATI for its products and/or projects.