

Figure 1. Physical Photo of AHV24VN25KV1MAW

FEATURES

- High precision
- Full modulation range on output voltage
- Linear regulation
- Shutdown

APPLICATIONS

This power module, AHV24VN25KV1MAW is designed for achieving DC-DC conversion from low voltage to high voltage. High voltage power supply is widely used in industrial measurement and control, energy spectrum analysis, and medical equipment such as: X-ray machine, vacuum/plasma processing, semiconductor fabrication equipment, analytical instrumentation, medical diagnostic and therapeutic systems, test equipment, and research and academic applications, etc.

DESCRIPTION

Draw a clear distinction between input lead and output lead: input 24V (red lead), ground electrodes (black lead), regulation wire (white lead), reference voltage 5V (yellow lead), shutdown (blue lead), output high-tension cable (thick red lead), and voltage monitor cable (brown lead).

While regulating the potentiometer, connect the intermediate tap of the potentiometer with white lead, and connect the other two ends to ground (black lead) and reference voltage (yellow lead) respectively. Switch on the power, and regulate

the potentiometer to have the required output voltage.

AHV24VN25KV1MAW converts an input DC voltage of 24V, to an output voltage of 25kV with high efficiency. It allows monitor the output voltage by measuring the voltage of an output voltage monitor port: multiplying the value 10000 times equals the output voltage. The whole converter is shielded by a heavy duty metal enclosure, which blocks EMIs from coming out of the module and going into the module. This feature is particularly important for noise intensive environment.

SHUTDOWN MODE OPERATION

A logic low <0.8V or a 0V on the SDN pin will turn the device off. When SDN is in logic high >1.2V or left unconnected, the product is working well.

SAFETY PRECAUTIONS

The internal protection circuit is provided in the high voltage power supply, but the high voltage short circuit shall be avoided.

Make sure the circuit is insulated perfectly, especially between the high voltage output and the surroundings so as to avoid electronic shock.



SPECIFICATIONS

Table 1. Characteristics. T_A = 25°C, unless otherwise noted

Parameter	Symbol	Condition	Min.	Typ.	Max.	Unit/Note
Input Voltage	V _{PS}		23	24	25	V
Quiescent Input Current	I _{INQ}	I _{OUT} = 0mA	200	250	300	mA
Full Load Input Current	I _{INFLD}	I _{OUT} = 1.0mA	1.5	1.6	1.7	A
Input Voltage Regulation Ratio	$\Delta V_{OUT}/\Delta V_{VPS}$	V _{VPS} = 23V ~ 25V		0.1		%
Output Voltage	V _{OUT}	I _{OUT} = 0 ~ 1.0mA	0		-25000	V
Maximum Output Current	I _{OUTMAX}	V _{VPS} = 23V ~ 25V			1.0	mA
Stability of Reference Voltage	V _{REF}	-20 ~ 50°C	4.95	5	5.05	V
Load				25		MΩ
Regulation Mode			0 ~ 5V or 10k potentiometer			
Control Input vs. Output Linearity	$\Delta V_{REF}/\Delta V_{OUT}$			<0.2		%
Load Regulation Rate		I _{OUT} = 0 ~ 1.0mA		≤0.05		%
Instantaneous Short Circuit Current	I _{SC}			<150		mA
Shutdown Supply Current	I _{SHDN}				15	mA
Shutdown Logic Input Current	I _{LOGIC}				3	uA
Shutdown Logic Low	V _{INL}				0.8	V
Shutdown Logic High	V _{INH}		1.2			V
Monitor Voltage Out Impedance	Z _{VMON}			1		MΩ
Monitor Voltage	V _{MON}	V _{OUT} = 0 ~ 30kV	0		3	V
Full Load Efficiency	η			≥70		%
Temperature Coefficient	TCV _O	-20 ~ 50°C		<0.1		%/°C
Time Drift	Short Time Drift			<0.3		%/ min
	Long Time Drift			<0.5		%/h
Output Voltage Temperature Stability		-20 ~ 50°C		<±0.5		%
Operating Temperature Range	T _{opr}		-20		55	°C
Storage Temperature Range	T _{stg}		-55		85	°C
External Dimensions			140×100×55			mm
Weight				1000		g
				2.21		lbs
				35.27		Oz



TESTING DATA

I. DC Testing

High voltage power supply testing data (Test condition: the load is 25 MΩ)

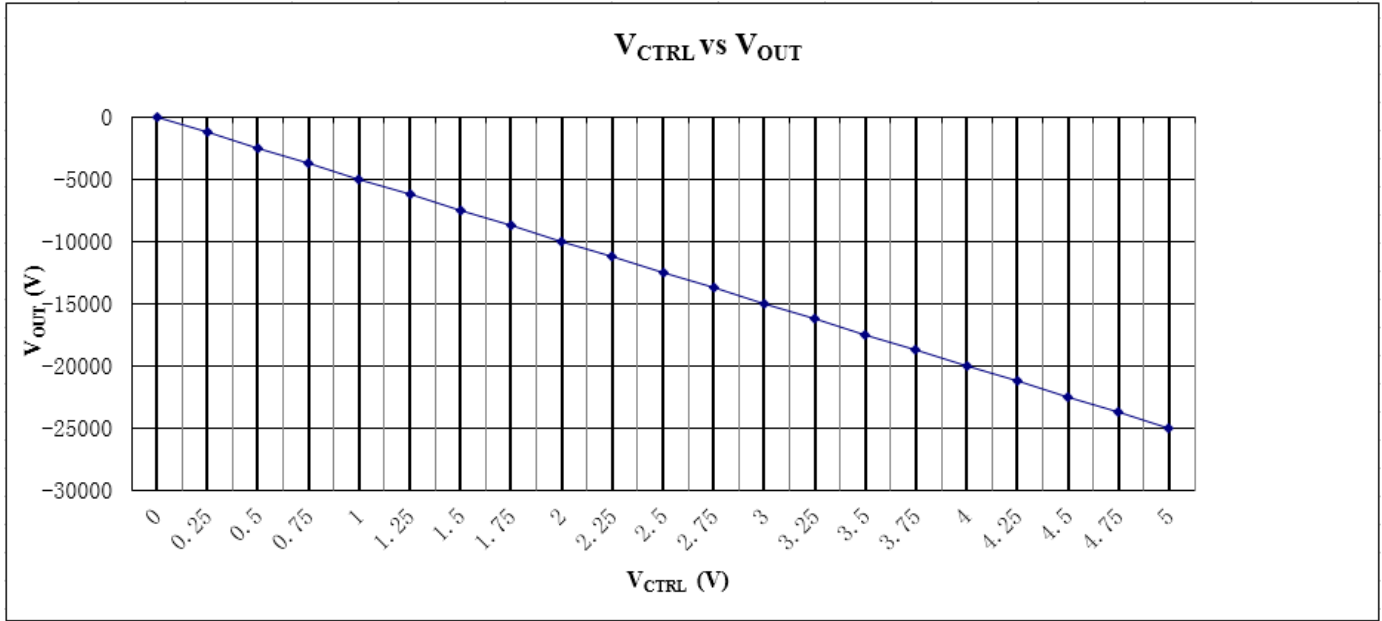

Figure 2. V_CTRL vs. V_OUT

II. AC Testing

Waveform curve and rise & fall time are tested by using the control voltage supplied by signal generator.

Under the testing condition of modulation frequency 0.1Hz, control voltage 0.25 ~ 5V, and 25MΩ load, the output voltage is -1250 ~ -25000V.

Note: as shown in the figures below, the output voltage is represented by yellow line and the control voltage by red line.

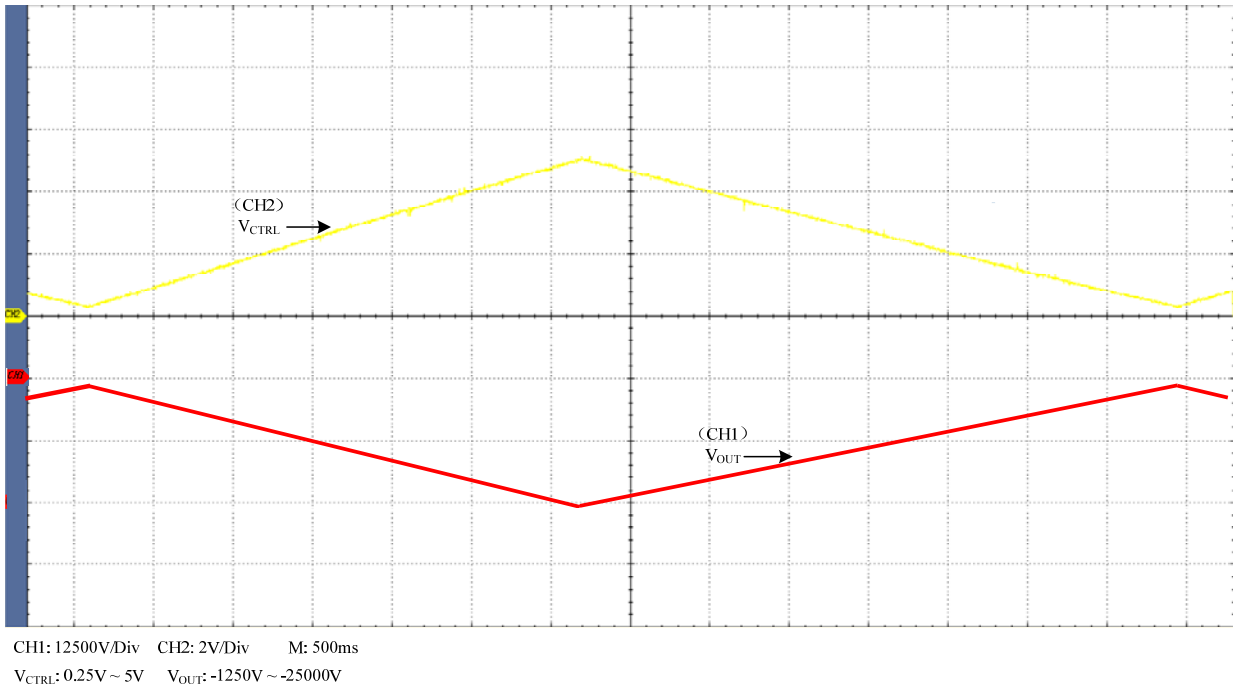

Figure 3. Triangle Wave

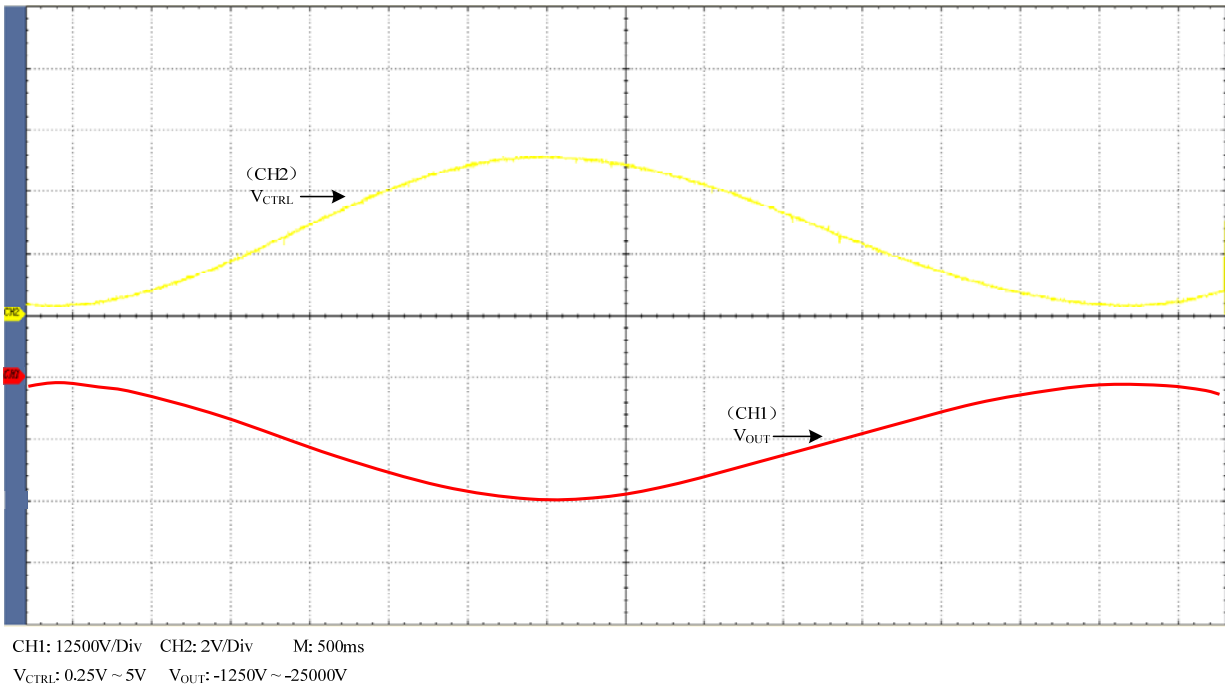

Figure 4. Sine Wave

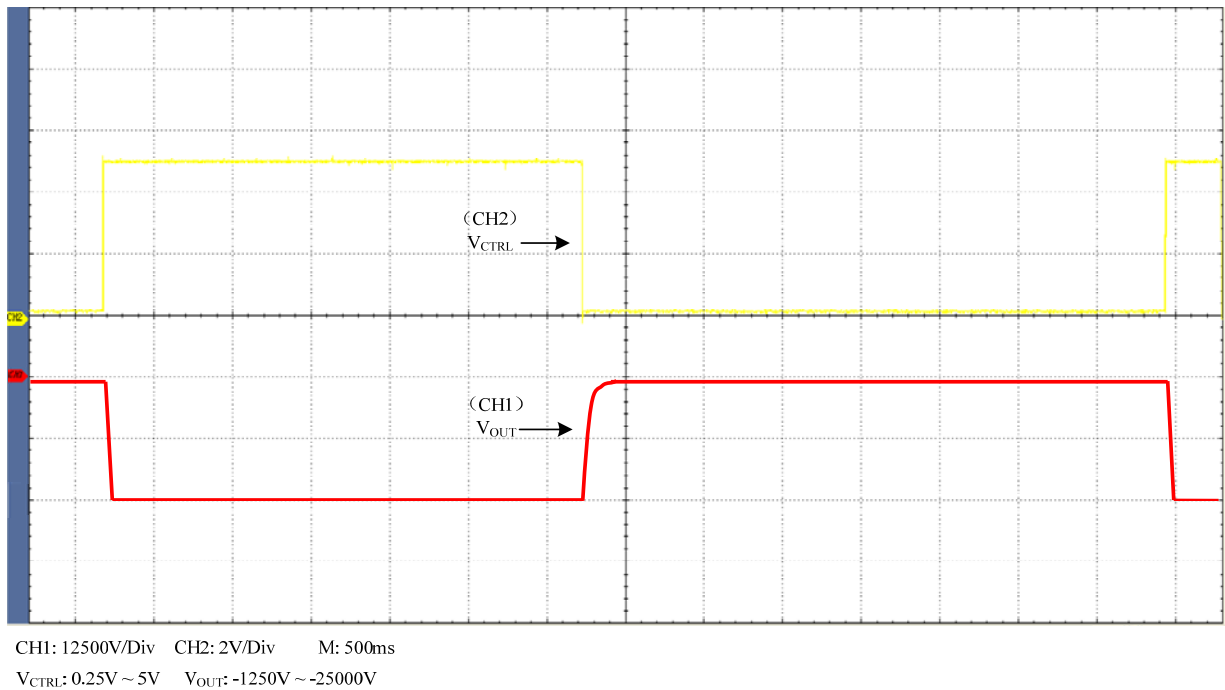

Figure 5. Square Wave

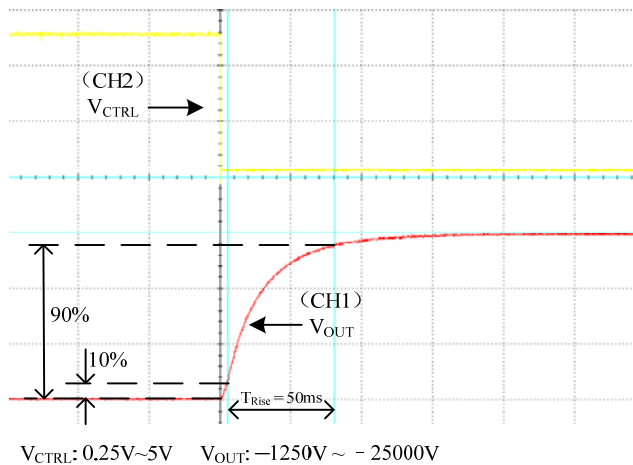

Figure 6. Rise Time

As shown in Figure 6, when a square wave of 0.25V ~ 5V, F=0.10Hz is applied to Control, measure the waveform. The rise time is about 30ms.

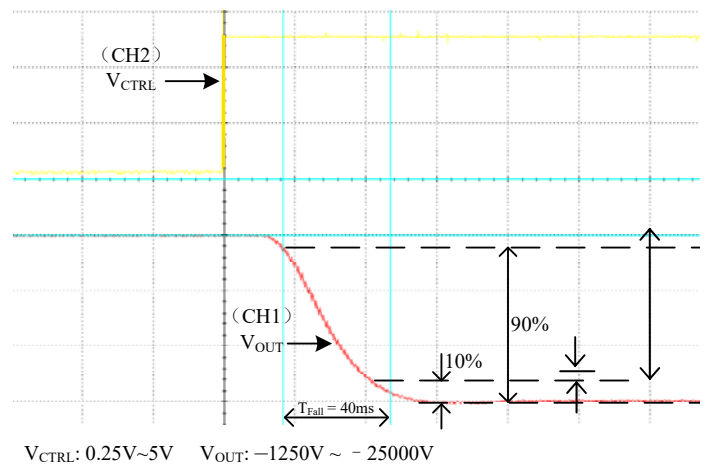

Figure 7. Fall Time

As shown in Figure 7, when a square wave of 0.25V ~ 5V, F=0.10Hz is applied to Control, measure the waveform. The fall time is about 100ms.



THE CONNECTION DIAGRAM OF MODULE'S PERIPHERAL CIRCUIT

The leads colors in the figures below are identical with those in the physical AHV24VN25KV1MAW.

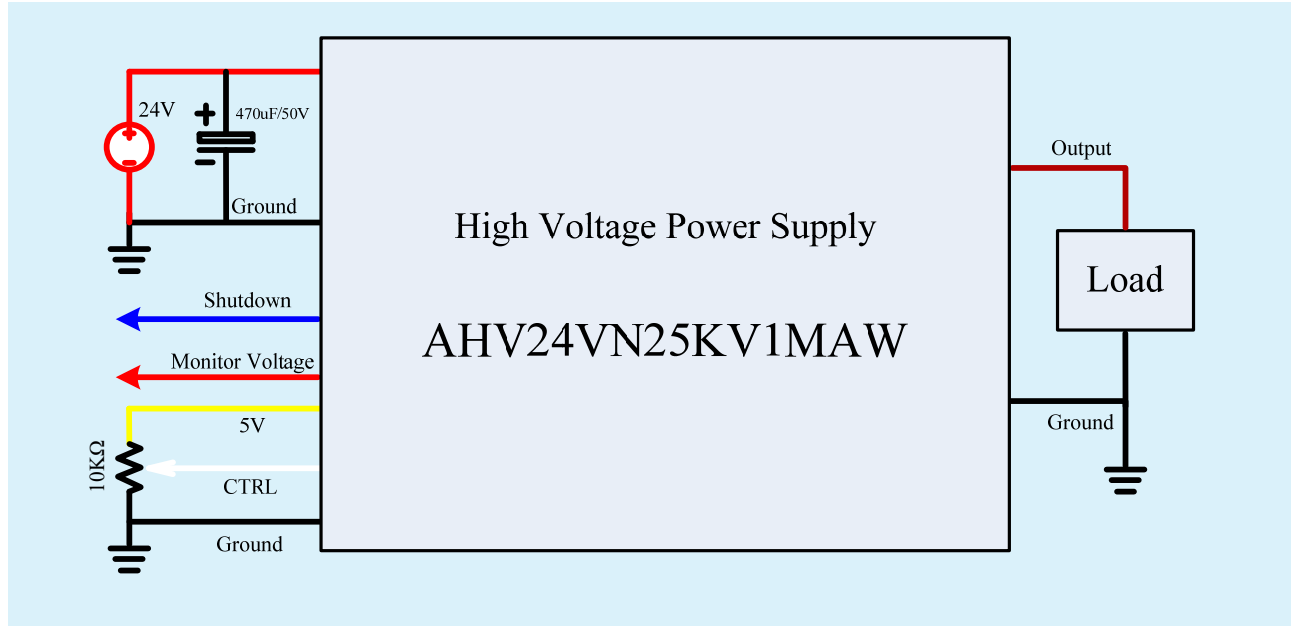

Figure 8. Figure 8. Control by External Source

NAMING INSTRUCTIONS

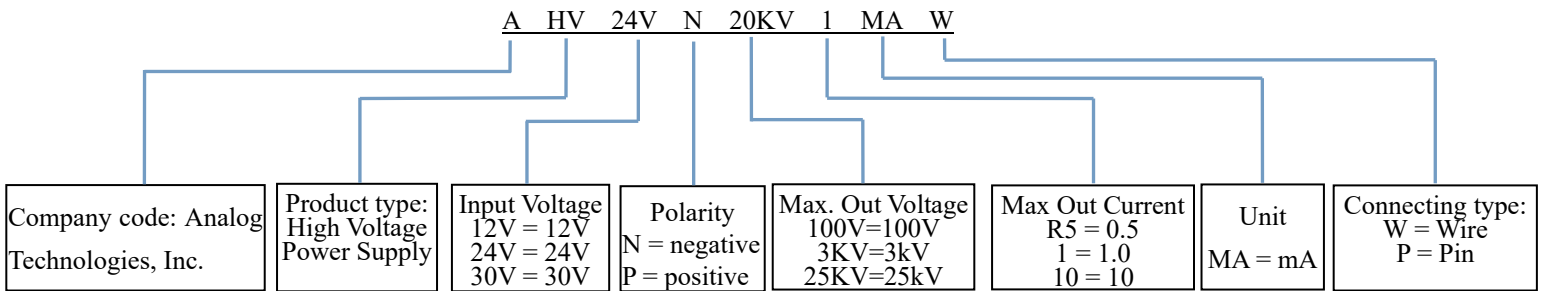

Figure 9. Naming Rules of AHV24VN25KV1MAW



DIMENSIONS

I. Dimension of the leads.

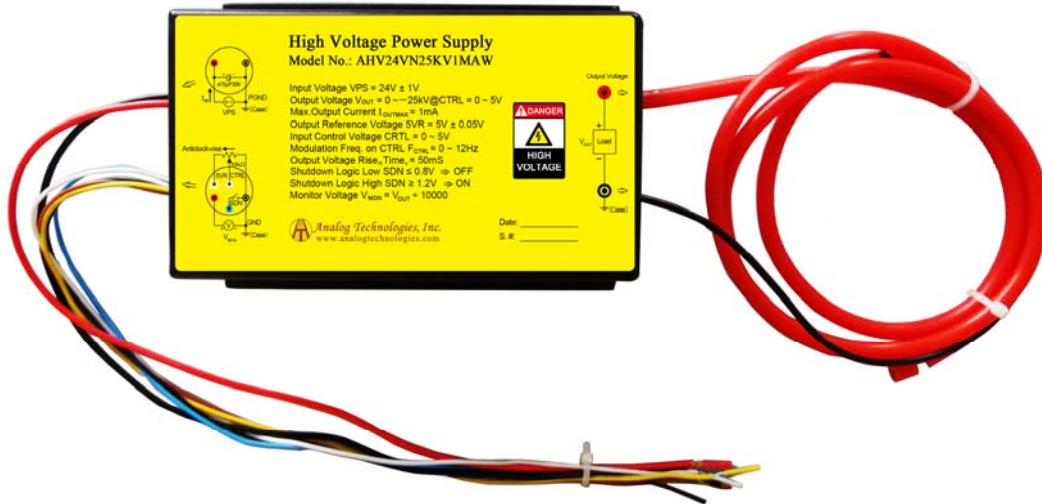

Figure 10. Leads of AHV24VN25KV1MAW

Leads	Diameter (mm)	Length (mm)
Thick brown lead	4.5	120
Yellow, red, blue, black and white leads	1.5	23

II. Dimension of AHV24VN25KV1MAW.

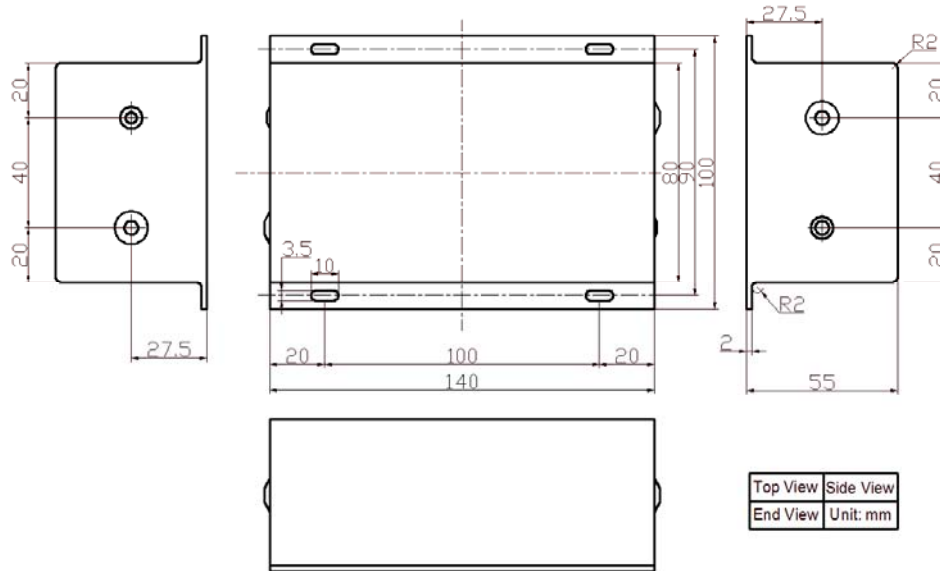

Figure 11. Dimensions for AHV24VN25KV1MAW



PRICES

Quantity (pcs)	1~9	10~49	50~99	≥100
AHV24VN25KV1MAW	\$419	\$409	\$399	\$389

NOTICE

1. ATI warrants performance of its products for one year to the specifications applicable at the time of sale, except for those being damaged by excessive abuse. Products found not meeting the specifications within one year from the date of sale can be exchanged free of charge.
2. ATI reserves the right to make changes to its products or to discontinue any product or service without notice, and advise customers to obtain the latest version of relevant information to verify, before placing orders, that information being relied on is current and complete.
3. All products are sold subject to the terms and conditions of sale supplied at the time of order acknowledgment, including those pertaining to warranty, patent infringement, and limitation of liability. Testing and other quality control techniques are utilized to the extent ATI deems necessary to support this warranty. Specific testing of all parameters of each device is not necessarily performed, except those mandated by government requirements.
4. Customers are responsible for their applications using ATI components. In order to minimize risks associated with the customers' applications, adequate design and operating safeguards must be provided by the customers to minimize inherent or procedural hazards. ATI assumes no liability for applications assistance or customer product design.
5. ATI does not warrant or represent that any license, either express or implied, is granted under any patent right, copyright, mask work right, or other intellectual property right of ATI covering or relating to any combination, machine, or process in which such products or services might be or are used. ATI's publication of information regarding any third party's products or services does not constitute ATI's approval, warranty or endorsement thereof.
6. IP (Intellectual Property) Ownership: ATI retains the ownership of full rights for special technologies and/or techniques embedded in its products, the designs for mechanics, optics, plus all modifications, improvements, and inventions made by ATI for its products and/or projects.